

NovaLCT

LED Configuration Tool for Synchronous Control System



User Manual

Contents

1 Software Introduction	1
2 Software Installation	2
3 Device Connection	3
3.1 Connect PC to Sending Card	3
3.2 Connect NovaLCT to Sending Card	3
4 User Login	5
5 Screen Configuration	6
5.1 Load Configuration Files	6
5.2 Configure a Screen Manually	7
5.2.1 Step 1 Set Input Source	8
5.2.2 Step 2 Light a Screen	10
5.2.3 Step 3 Connect Screen	20
5.2.4 Step 4 (Optional) Save Configuration Files	24
5.3 Set Redundancy	26
5.4 Enable 3D	29
5.5 Set Working Mode	30
5.6 Enable Zoom	33
5.7 Set Audio Input	34
5.8 Set Performance Parameters	35
6 Brightness and Chroma Adjustment	42
6.1 Calibration	42
6.1.1 Set Online Calibration Parameters	42
6.1.2 Get Average Coefficients	43
6.1.3 Manage Calibration Coefficients	44
6.1.4 Manage Double Calibration Coefficients	48
6.2 Adjust Brightness	49
6.2.1 Adjust Brightness Manually	49
6.2.2 Adjust Brightness Automatically	55
6.3 Adjust Multi-batch Cabinets	58
6.4 Adjust Dark or Bright Lines	63
6.5 Correct Brighter Pixels	66
6.6 Set Advanced Color	67
6.7 Adjust Screen Effect	71
6.8 Set Image Booster Engine	72
6.9 Batch Check Calibration Effects	76
7 Screen Monitoring	78
7.1 Register Screens with VNNOX Care	78
7.1.1 Register Online Screens	78
7.1.2 Register Offline Screens	81
7.2 View and Configure Monitoring	85
8 Screen Management	90
8.1 Multi-function Card Management	90
8.2 Multiple-screen Management	95
8.3 Prestore Screen	97
8.4 Receiving Card Relay	98
8.5 Configuration Information Management	100
8.6 Screen Control	100
8.7 Controller Cabinet Configuration File Import	102
8.8 Video Control	103

8.9 Module ID Settings	105
8.10 Sending Card Relay Settings	107
8.11 Optical Port Settings	108
9 Screen Maintenance	110
9.1 Firmware Program Update	110
9.2 LED Error Detection	111
9.3 Reset Run Time.....	113
9.4 Bit Error Detection	114
9.5 View Hardware Information	115
9.6 Send NCP Files.....	117
9.7 Set Cabinet Dehumidification	119
10 Plug-in.....	122
10.1 Test Tool	122
10.2 Calculator	122
10.3 External Program.....	122
11 Software Settings.....	124
11.1 Configure the Save Function	124
11.2 Cloud Server Configuration	124
11.3 Set Main Window Starting Position.....	125
11.4 Change UI Language.....	126
11.5 Obtain Help Information.....	126
11.6 Update Software	127
12 Troubleshooting	129
12.1 Installation Problems	129
12.1.1 Failed to install NovaLCT of earlier versions.....	129
12.1.2 .NET Framework is missing.....	129
12.1.3 "DeleteFile failed" error.....	129
12.1.4 Prompts to run DPinst.exe.....	130
12.2 Other Problems	131
12.2.1 "No Screen" displayed in NovaLCT	131
12.2.2 Permission error	131
12.2.3 Failed to connect colorimeter.....	134
12.2.4 No available server for VNNOX Care	135
13 FAQs.....	136
13.1 How do I set the required parameters in no sending card mode?	136
13.2 How do I set the proxy when NovaLCT needs to access WAN network?.....	137

1 Software Introduction

The LED display control systems are categorized into synchronous control system and asynchronous control system. In synchronous control system, the images are played and controlled on the screen synchronously with the video source (such as on PC or camera). In asynchronous control system, they are played and controlled asynchronously. The program is pre-stored on the local playback device and then played according to the playback schedule.

No matter in which control system, the application scenario requires a piece of supporting software to configure the control system. Based on the needs of different users, NovaStar has designed and developed an LED screen configuration tool — NovaLCT.

As a basic screen configuration tool running on Windows, NovaLCT has the following features.

✦ Easy to install

The latest installation package can be downloaded from NovaStar official website www.novastar.tech at any time and it is quick and easy to install.

✦ Practical functions

A lot of commonly used functions are provided, such as screen configuration, screen monitoring, redundancy settings, brightness adjustment, multi-batch adjustment, dark or bright line adjustment, multifunction card management and other configuration functions. Thanks to these functions, the screen can present optimal display effect and is easy to manage and maintain.

✦ Wide scope of applications

NovaLCT can be used to configure NovaStar synchronous control system products and multimedia players of asynchronous control system. It meets different needs of screen manufacturers, contractors, distributors, rental application clients, end users and technical support engineers.

✦ Efficient configuration

After the PC and control system product are connected, users can perform any operations with the PC. NovaLCT displays the corresponding functions and parameters according to the different hardware models and programs. During configuration, various kinds of configuration files can be used to complete operations quickly. If the configuration information is saved to the hardware, it will not be lost even after the hardware is powered off.

2 Software Installation

Obtaining Software

Visit www.novastar.tech and choose **DOWNLOADS > Software**. In the NovaLCT area, download the needed version of software installation package.

Figure 2-1 Obtaining software

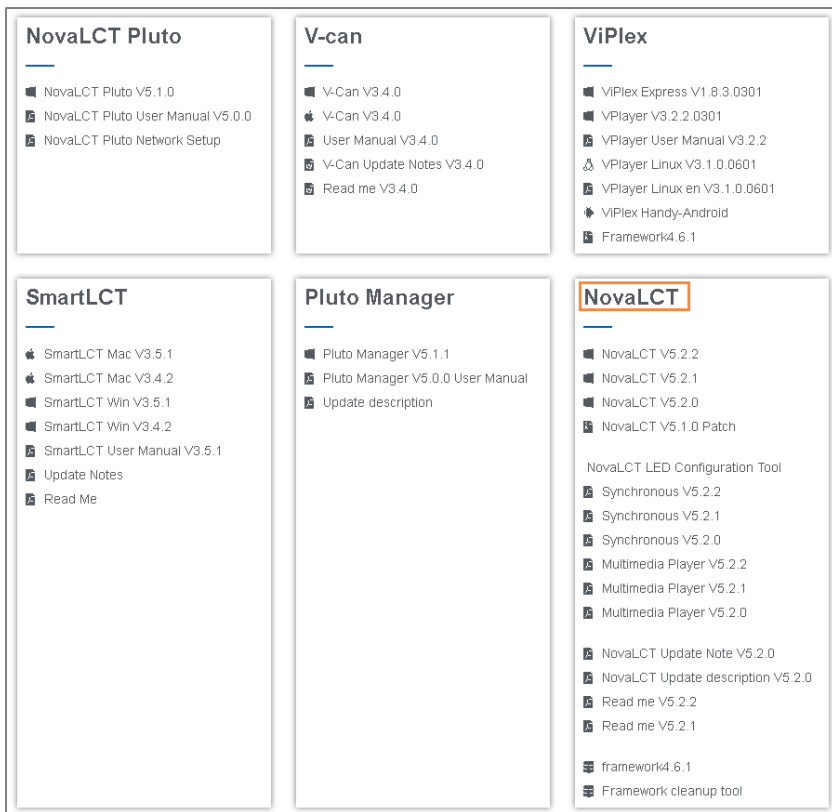



Installing Software

Before installing NovaLCT, prepare a Windows PC and disable the antivirus software.

Unzip the installation package, run the .exe file and follow the setup wizard to complete the installation. If a firewall prompt appears, choose to allow the installation.

If the PC does not have the serial port driver program or the program version is earlier, the NovaLCT installation program will automatically install or update the program.

Verifying Installation

If the installation is successful, the shortcut  appears on the desktop, and  and  icons appear on the taskbar.

3 Device Connection

3.1 Connect PC to Sending Card

Connect the PC with NovaLCT installed to the sending card with control cable (USB cable or Ethernet cable), as shown in Figure 3-1. The MCTRL4K is used as an example of sending device.

All control commands, parameters and configuration files are transmitted with the control cable.

The PC can also be connected to multiple sending cards with control cable. After selecting a target communication port in NovaLCT, you can operate the connected device.

Figure 3-1 Hardware connection example

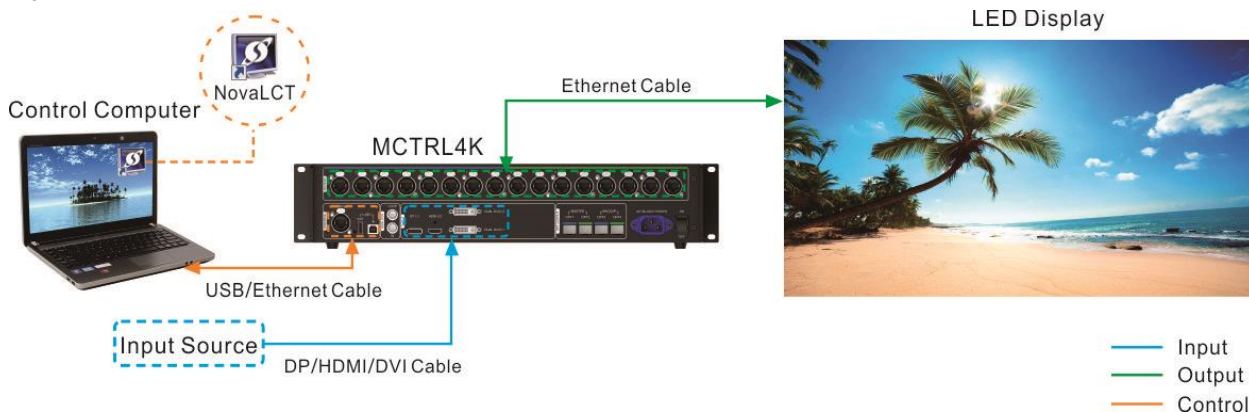

If the receiving card supports no sending card mode, the PC with NovaLCT installed can be directly connected to the receiving card with Ethernet cable. For related settings, see 13.1 How do I set the required parameters in no sending card mode?

3.2 Connect NovaLCT to Sending Card

If the hardware connection is normal and the sending card is operating normally, NovaLCT connects to the sending card automatically. After successful connection, the NovaLCT main window displays the sending card quantity and monitoring information about the control system, as shown in Figure 3-2.

Figure 3-2 Main window (Not logged in)

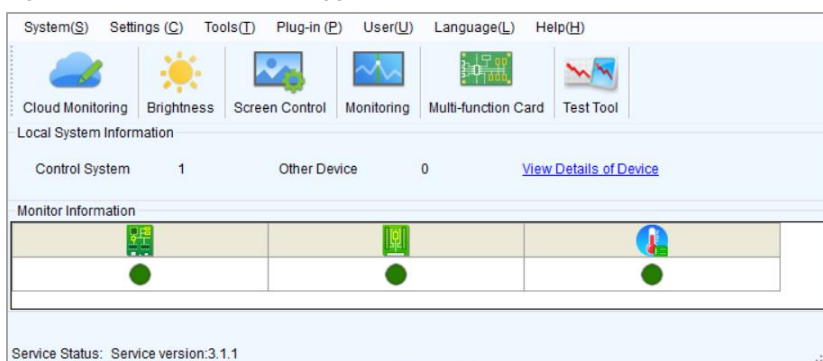

Click **View Details of Device** to view the communication port, device name, device quantity and SN. If the communication port information contains IP address, NovaLCT communicates with the device via Ethernet port. If it contains "USB" characters, they communicate via USB port. "SN" is the unique identifier of the sending card.

Connection related operations:

✦ **Reconnect sending card**

Choose **System > Reconnect**.

✦ **Restart server**

On the taskbar, right click  and click **Restart**.

✦ **Set connection parameters**

On the taskbar, right click , click **Detect Config** and set the marked parameters in the figure below.

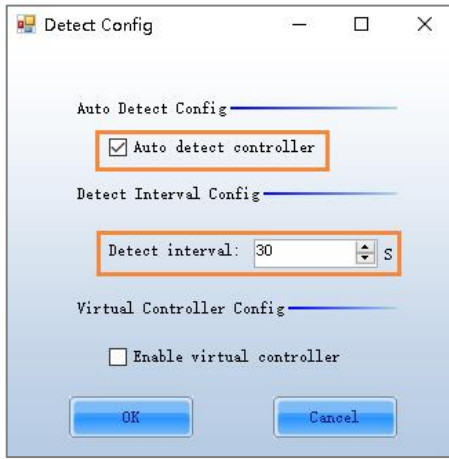

4 User Login

Sending Card Connected

If the sending card is connected, users can directly use the available functions without login. To use the advanced functions, users must log in to NovaLCT.

Operations:

Choose **User > Advanced Synchronous System User Login**. Enter the password and click **Login**. The default password is “admin”.

After successful login, the main window is shown as [Figure 4-1](#).

Figure 4-1 Main window (Logged in)

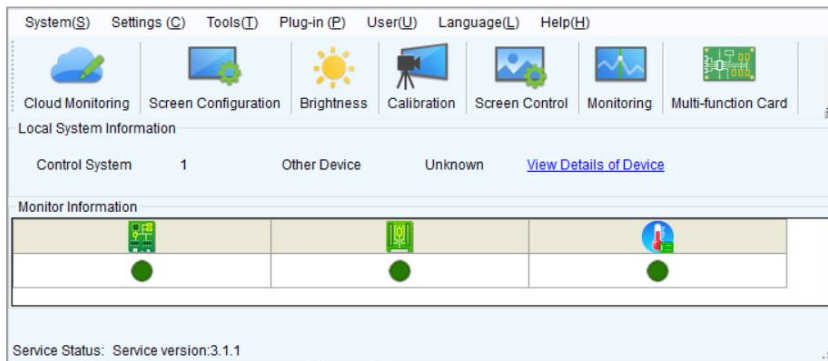

Other Operations:

- To log out, choose **User > Logout**.
- To change the login password, choose **User > Change Password**.

Sending Card Not Connected

If the sending card is not connected and users want to learn about the functions, use the demonstration mode.

Operations:

Choose **User > Demonstration Login**. Enter the password “admin” and click **Login**.

5 Screen Configuration

Notes

NovaLCT currently only supports configuring regular screens. Irregular screens are not supported.

5.1 Load Configuration Files

Applications

Load a cloud or local configuration file to finish screen configuration quickly.

Applicable Products

All receiving cards and sending cards

Prerequisites

- Load a cloud configuration file: The control computer is connected to the Internet.
- Load a local configuration file: The system configuration file (.scfg and .zip) is prepared.

Related Information

- The information in the cloud configuration file and local .zip file can be viewed in NovaLCT, but cannot be modified before the information is sent to the hardware.
- The information in the local .scfg file can be viewed and modified in NovaLCT before the information is sent to the hardware.

Operating Procedure

Step 1 On the menu bar, choose **User > Advanced Synchronous System User Login**. Enter the password and click **Login**.

The default password is “admin”.

Step 2 Click  or choose **Settings > Screen Configuration** from the menu bar to open the dialog box shown in Figure 5-1.

Figure 5-1 Screen configuration method

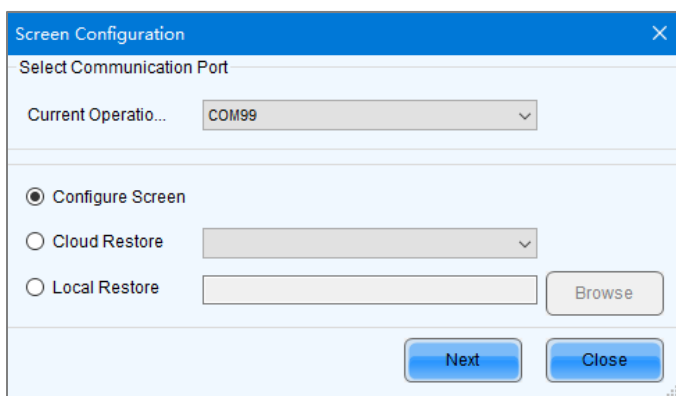

Step 3 Choose a communication port.

If the PC is connected to multiple sending cards with control cable, there are multiple ports in the drop-down list.

Step 4 Perform any of the following operations as needed to load a configuration file.

- ✦ **Load from cloud platform**

- a. Select **Cloud Restore** and select a node from the drop-down list.
- b. Click **Next** to open the **Restore Configuration File** dialog box.

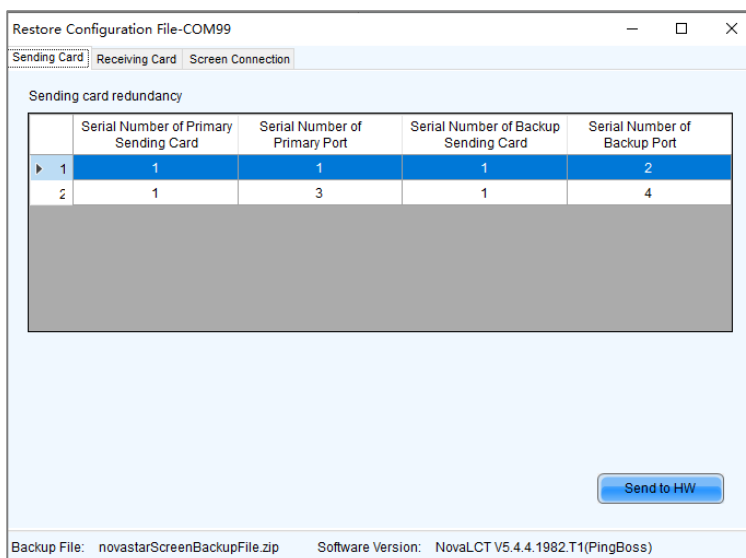

- c. Select a tab as needed and send the configuration file to the hardware.
 - Sending Card:** Click **Send to HW** to send the Ethernet port redundancy configuration file of the sending card to the hardware.
 - Receiving Card:** Select **Send By Topology** or **Send By Physical Address**, set the related parameters, and click **Send to Specified RV Cards** to send the receiving card configuration file to the hardware. When you have selected **Select by Topology or List**, if it is not convenient to select an area with the software, you can select **Select Operating Area on Screen** to select the area on the display window.
 - Screen Connection:** Click **Send to HW** to send the screen connection file to the hardware.
- d. In the displayed dialog box, click **Save to HW** or **Don't Save to HW**.

+ **Load from local PC**

- a. Select **Local Restore**.
- b. Click **Browse**, select a configuration file, and click **Open**.
- c. Click **Next**.

For the .zip local configuration file, see the figures and steps in the **Load from cloud platform** section. For the .scfg local configuration file, the loading progress will be displayed. After the file is loaded, the dialog box shown below is closed automatically.

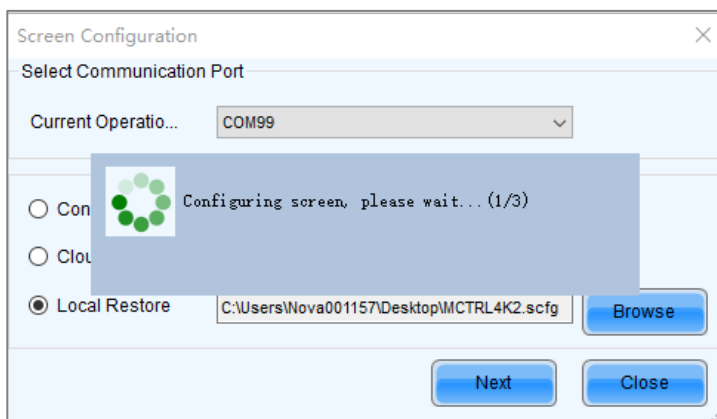

5.2 Configure a Screen Manually

For a common screen, set the input source, light the screen and connect the screen in order to complete the screen configuration.

Notes

The screen configuration page in NovaLCT varies depending on the functions supported by the sending card and receiving card.

5.2.1 Step 1 Set Input Source

Applications

Set the input source type, resolution, refresh rate and bit depth for the sending card to make the screen display the specified input source pixel to pixel.

Applicable Products

The V1160 and VX16s all-in-one devices, and other sending cards

Prerequisites

None

Related Information

If the resolutions of the sending card and screen are the same, the image can be displayed pixel to pixel.

If the refresh rate is too low, the screen flickers. A higher refresh rate helps stabilize the display image.

Operating Procedure

Step 1 On the menu bar, choose **User > Advanced Synchronous System User Login**. Enter the password and click **Login**.

The default password is "admin".



Step 2 Click **Screen Configuration** or choose **Settings > Screen Configuration** from the menu bar to open the dialog box shown in Figure 5-2.

Figure 5-2 Screen configuration method

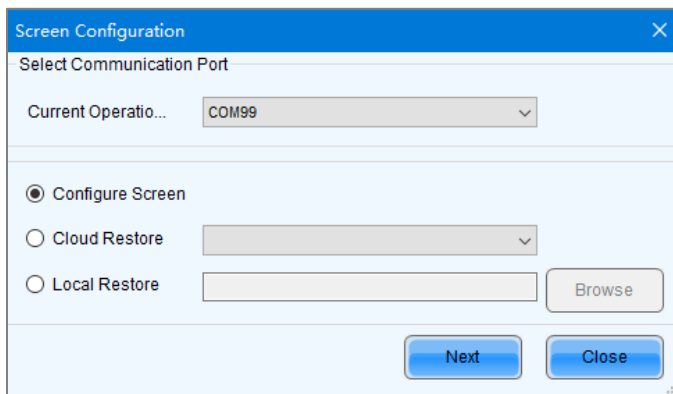

Step 3 Choose a communication port.

If the PC is connected to multiple sending cards with control cable, there are multiple ports in the drop-down list.

Step 4 Select **Configure Screen** and click **Next** to open the **Screen Configuration** page.

Figure 5-3 Screen configuration

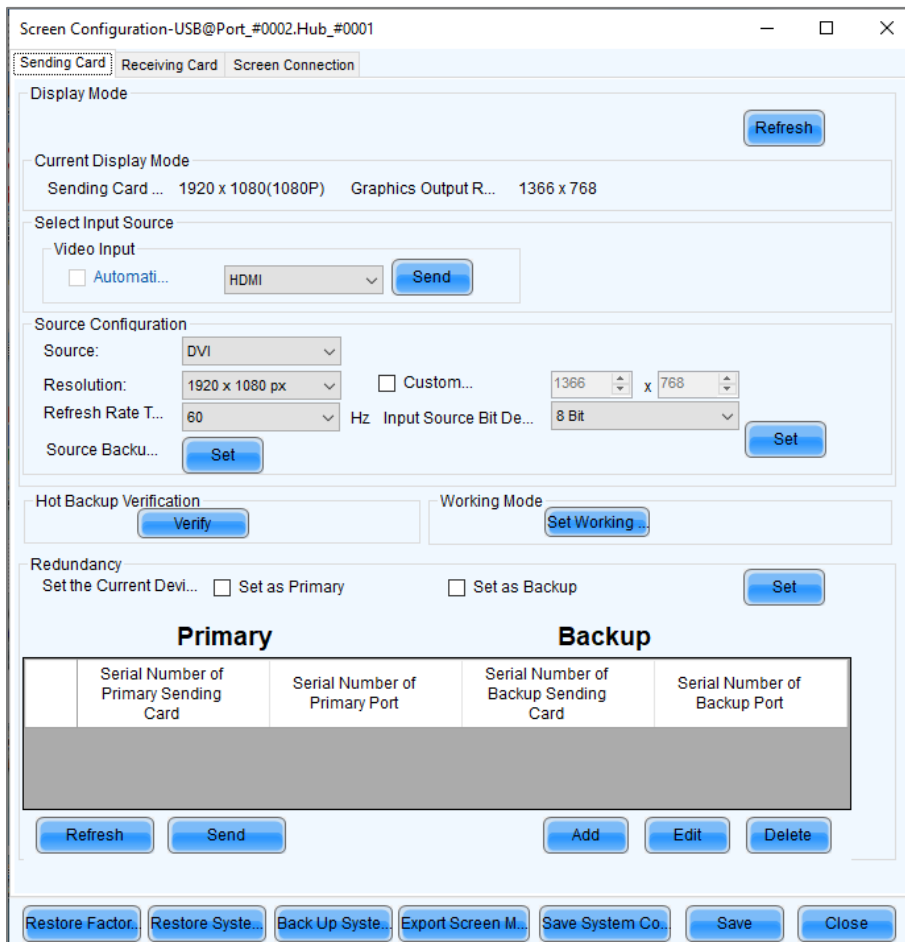

Step 5 On the **Sending Card** tab page, view the current display mode, as shown in Figure 5-4.

Figure 5-4 Input source information

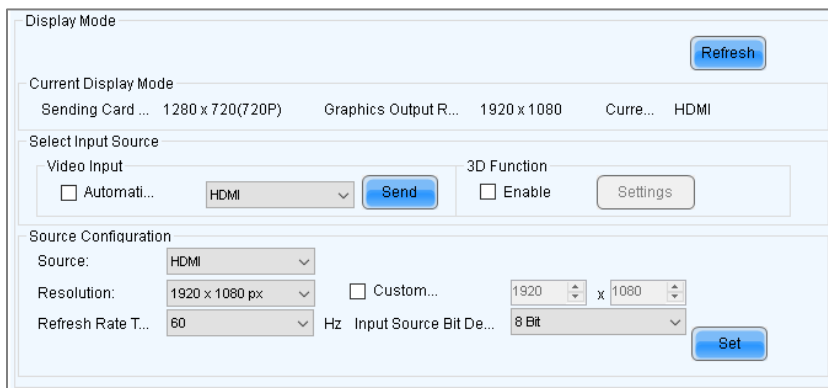

Step 6 Select **Automatic Selection** to allow NovaLCT to automatically select the input source according to the input signal, or select an input source from the drop-down list.

Step 7 Click **Send** to send the configuration information to the hardware.

Step 8 In the **Source Configuration** area, set the input source type and the corresponding resolution. You can select a resolution from the drop-down list or customize a resolution.

Step 9 Set the refresh rate and bit depth of input source.

After you change the refresh rate, you are advised to resend the performance parameters on the **Receiving Card** tab page to avoid the problem that the receiving card cannot automatically fit the refresh rate.

The recommended input source bit depth is 8 bit.

Step 10 For the MCTRL660 PRO and MCTRL R5, you can perform the following operations to set input source backup if necessary. Otherwise, skip this step.

1. Click **Set** next to **Source Backup Setting**.

2. Select **Start source backup**.
3. Set the input source backup relation and click **OK**.

Figure 5-5 Source backup settings

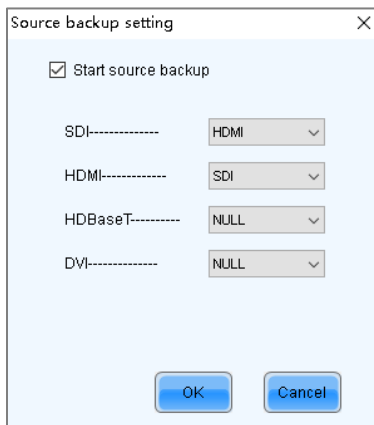

Step 11 Click **Set** to send the configuration information to the hardware.

Step 12 Click **Refresh** to confirm the result of input source setting.

Step 13 Click **Save** to save the configuration information to the hardware.

Step 14 After successful saving, choose whether to save the backup file to the local computer.

When the control computer can access the Internet, you can use the backup file to register screens to VNNOX Care. For details, see [7.1.2.1 Register by Using Local Backup Files \(Recommended\)](#).

This step is related with the configuration of the save function. See [11.1 Configure the Save Function](#).

Figure 5-6 Successful saving

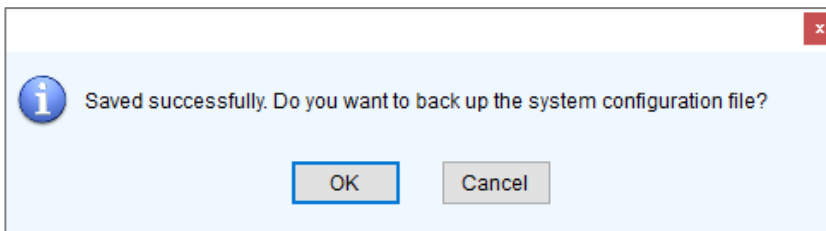

Notes

You can click **Restore Factory Settings** on the **Sending Card** tab page to reset the sending card configuration information to factory settings.

5.2.2 Step 2 Light a Screen

5.2.2.1 Loading from File

Applications

Quickly light a screen by loading a receiving card configuration file saved in the local computer.

Applicable Products

All receiving cards

Prerequisites

- The receiving card firmware supports the module chip.
- The necessary file is prepared (.rcfgx/.rcfg).

Related Information

None

Operating Procedure

Step 1 On the **Screen Configuration** page, click the **Receiving Card** tab.

Figure 5-7 Screen configuration

The screenshot shows the 'Receiving Card' tab in the configuration tool. It is divided into three main sections:

- Module Information:** Displays 'Chip: Common C...', 'Size: 32W*16H', 'Scanning Type: 1/8 scan', 'Direction: Horizontal', and 'Data Groups: 2'. There is an 'Adjust RG...' link and a 'Check M...' button.
- Cabinet Information:** Features a 'Set Rotation' link. It has two radio buttons: 'Regular' (selected) and 'Irregular'. Under 'Regular', there are input fields for 'Width (Pixel): 32' (with '<=65' next to it) and 'Height (Pixel): 16' (with '<=128' next to it), and a 'Module Casc...' dropdown set to 'From Right to Left'. Under 'Irregular', there are 'Width: ??' and 'Height: ??' fields, a 'Loading error. Please try to adjust pe...' message, and 'Construct Ca...' and 'View Cabinet' buttons.
- Performance Settings:** Includes a 'Data Group E...' button, a 'More Settings' button, and a checkbox for '18bit+'. It contains numerous dropdown menus and input fields for parameters like 'Refresh Rate: 480 Hz', 'Refresh Rate TI...: 4', 'Grayscale Level: Normal 4096', 'Grayscale Mode: Refreshing Rate Fir', 'Shift Clock Fre...: 12.5 MHz', 'Duty Cycle: 50 (25~75) %', 'Phase Position: 6', 'Low Grayscale C...: 0', 'Row Blanking...: 15 (=1.20us)', 'Ghost Control En...: 13 (1~14)', 'Line Changing...: 3 (0~12)', 'Minimum OE w...: 160 ns', and 'Brightness Effi...: 68.96%'.

At the bottom, there are several action buttons: 'Smart Settings', 'Receiving Car...', 'Load from...', 'Save to File', 'Read from Re...', 'Send to Recei...', 'Current Receiving ...' (with 'mo...' and 'Version:' dropdowns), 'Restore Facto...', 'Export Screen M...', 'Save System Co.', 'Save', and 'Close'.

Step 2 Click **Load from File** and select a configuration file from the local computer.

Step 3 After successful loading, click **OK**.

Step 4 Click **Send to Receiving Card**. In the displayed dialog box, select **All Receiving Card** or specify receiving cards and click **Send**.

- All Receiving Card: Send the receiving card configuration information to all the receiving cards loaded by the current sending card. If you select **Reset the Starting Coordinate of Receiving Card**, the starting coordinates of all the receiving cards will be reset to (0, 0). As a result, all the receiving cards display the top-left image of the input source.
- Specify Receiving Card: Send the receiving card configuration information to the specified receiving cards by topology or by physical address.

Figure 5-8 Sending parameters to receiving card

The dialog box titled 'Send Parameters to Receiving Card' has a close button (X) in the top right corner. It contains two radio button options: 'All Recei...' (selected) and 'Specify Receiving Card'. Next to the 'All Recei...' option is a checkbox labeled 'Reset the Starting Coordinate ...'. At the bottom right, there are 'Send' and 'Cancel' buttons.

Step 5 After successful sending, click **OK** to close the prompt box. The screen is now lighted.

5.2.2.2 Manual Screen Configuration

5.2.2.2.1 Light Module

Applications

Set the receiving card parameters to light a new module.

Applicable Products

All receiving cards

Prerequisites

- The receiving card firmware supports the module chip.
- The display settings on the PC are completed. For example, display settings on Windows 10 are shown in [Figure 5-9](#) and [Figure 5-10](#). The resolution of PC graphics card must be set to be greater than or equal to the screen resolution based on the actual condition.

Figure 5-9 PC display settings 1

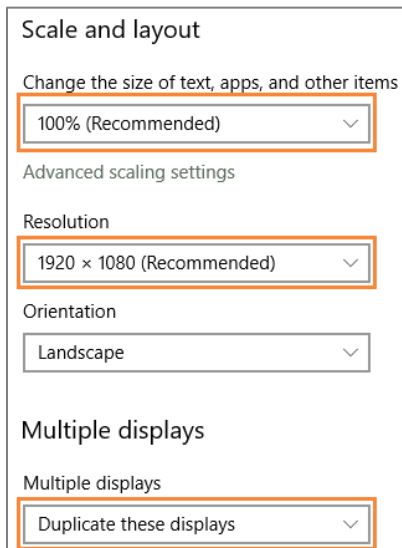
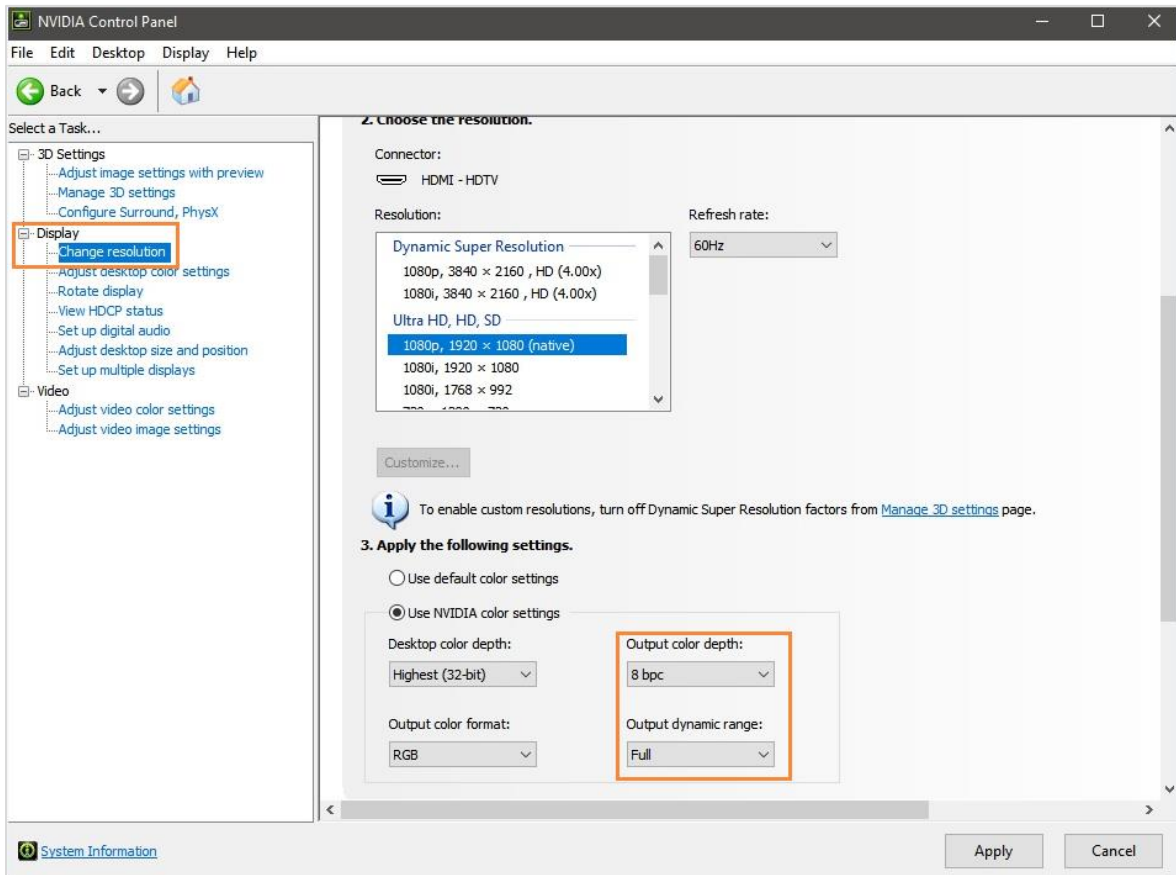

Figure 5-10 PC display settings 2



Related Information

The module specifications are provided when the module is shipped. Users can also obtain the specifications from the driver chip, decoding chip and pin definition on the module.

For example, the following information can be obtained from the module shown in Figure 5-11.

- Driver chip: 24 SUM2016GAS2 chips
- Data type: 2 groups of parallel RGB data
- Module type: Regular module
- Pixel quantity: 64 columns x 32 rows
- Decoding chip: 2 SUM74HC138 chips

Figure 5-11 Module example

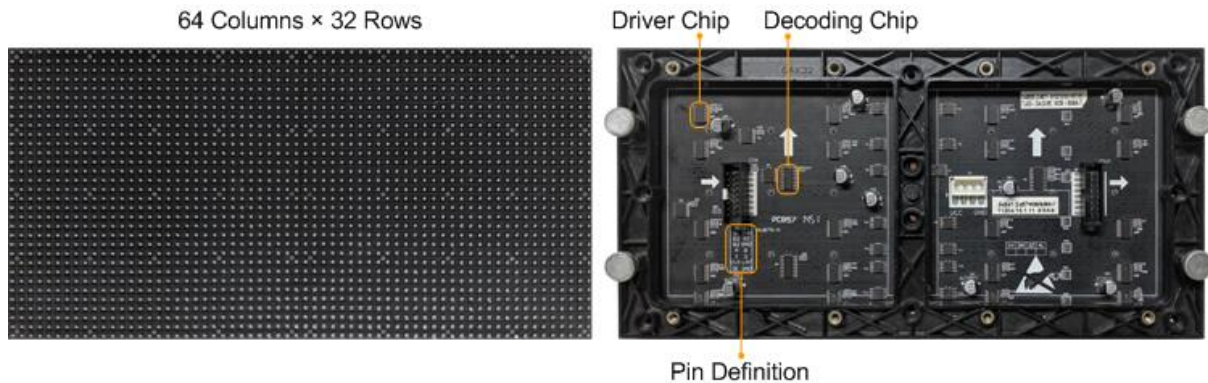

Both regular and irregular modules are rectangular. If the module column quantity can be divided by 16 without remainder, the module is a regular one.

An irregular module has any of the following features:

- Some output pins of the driver chip are not used.

- The numbers of pixel rows or columns driven by each data group are different.
- The data groups do not drive the pixel rows or columns in order.

Operating Procedure

Step 1 On the **Screen Configuration** page, click the **Receiving Card** tab.

Figure 5-12 Screen configuration

Step 2 Click **Smart Settings**.

Step 3 Select option 1 and click **Next**.

- Option 1: Enter smart settings.
- Option 2: Load a module configuration file to quickly configure the module.
- Option 3: Load the module configuration file in the cabinet database to quickly configure the module.

After the configuration file is loaded, click **Send to Receiving Card**.

Figure 5-13 Smart settings options

Step 4 On the **Smart Settings Guide 1** page, set the parameters and click **Next**.

Figure 5-14 Smart Settings Guide 1

- **Module Chip:** Select the type of module driver chip. You can click **Select chip type** to open the chip table and select the desired chip. If the table does not have the type of chip you want, select **Common Chip**.
- **Data Type:** Select the data type of the module. Parallel data indicates that the data of the RGB three colors is transmitted parallelly, but serial data indicates that the data of the RGB three colors is transmitted serially.
- **Module Type:** Select the module type. Module type includes regular and irregular modules.
- **Number of Driver Chips for One Scan and One Color:** This parameter is available when irregular module is selected. It is calculated by the following formula.

$$\text{Number of driver chips for one scan and one color} = \text{Number of driver chips} / \text{Number of data groups} / \text{Number of colors}$$
- **Quantity of Pixels:** Set the quantity of pixel columns and rows on the module.
- **Row Decoding Type:** Select the row decoding type of the module. You can click **Select a decoding type** to open the decoding type table and select the desired type. When the **Parity Scan** option is displayed, if only the odd or even output of the decoding chip is used, please select this option.
- **Hub Mode:** Use the default value.
- **Ghost Control Signal Polarity:** Use the default value.

Step 5 On the **Smart Settings Guide 2** page, select one option based on the current display on the module and click **Next**.

When you are viewing the display on the module, view the first module loaded by the first receiving card connected to the first Ethernet port.

Figure 5-15 Smart Settings Guide 2

Step 6 On the **Smart Settings Guide 3** page, select the module display color switching mode and check whether the current module display color is the same as the selected color.

Figure 5-16 Smart Settings Guide 3

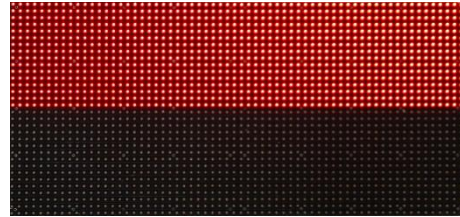
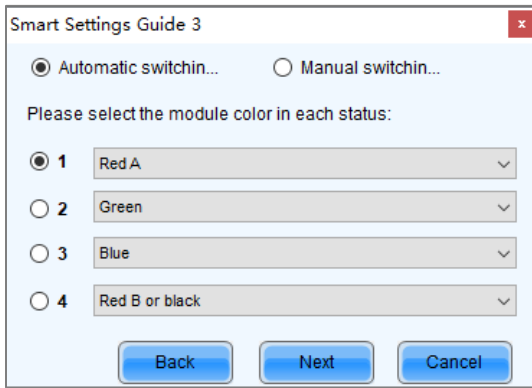

- If they are the same, click **Next** to go to Step 7.
- If they are different, select a color corresponding to the module display color from the drop-down list to make them the same.

Step 7 On the **Smart Settings Guide 4** page, set the parameters based on the number of lighted rows (or columns) on the module and click **Next**.

Figure 5-17 Smart Settings Guide 4

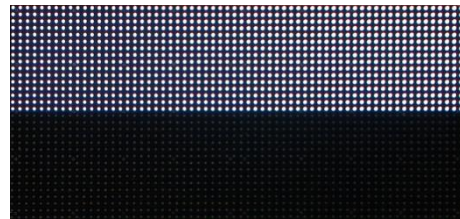
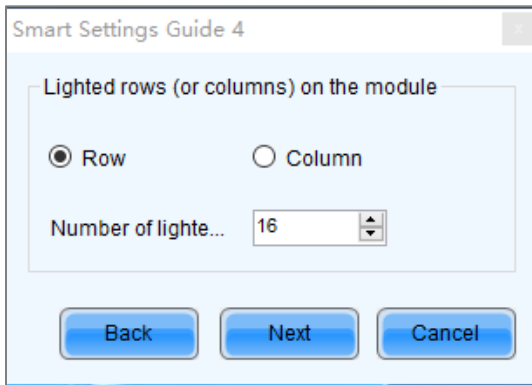

Step 8 On the **Smart Settings Guide 5** page, set the parameters based on the number of lighted rows (or columns) on the module and click **Next**.

Figure 5-18 Smart Settings Guide 5

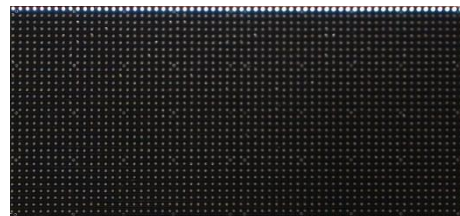
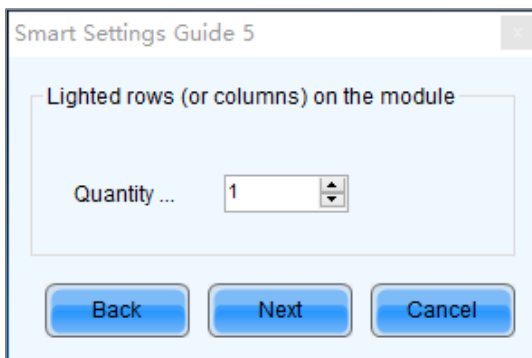

Step 9 On the **Smart Settings Guide 6** page, view the flashing pixel in the first row on the module and click the corresponding cell in the grid to draw the pixel position.

Generally, you only need to draw pixel position for the first row of pixels. If the flashing pixels are on the other row or column, click the corresponding cells in the grid.

- Automatic Generation: Complete pixel position drawing for the first row of pixels quickly.
- Cancel: Clear the last pixel position drawing.
- Clear: Clear all the pixel position drawing.
- Lighted Pixels: Display the total number of lighted pixels on the current module.



- Unlighted Pixels: For regular modules, the value of this parameter is always 0. For irregular modules, a **No corresponding LED** button is added to the page shown in Figure 5-19. When a pixel cannot be lighted during pixel position drawing, you can click **No corresponding LED** and the number of **Unlighted Pixels** increases by 1.
- : Zoom out the grid.
- : Zoom in the grid.

Figure 5-19 Smart Settings Guide 6



Step 10 View the flashing pixel in the first column on the module and click the corresponding cell in the grid to draw the pixel position (You can also use the keyboard arrow key to quickly draw the position), and click **OK** after the drawing is done.

Generally, you only need to draw pixel position for the first column of pixels. If the flashing pixels are on the other row or column, click the corresponding cells in the grid.

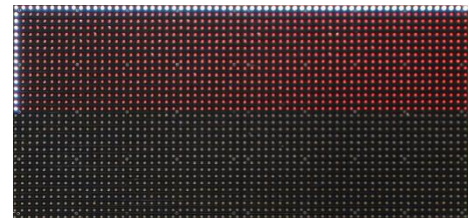
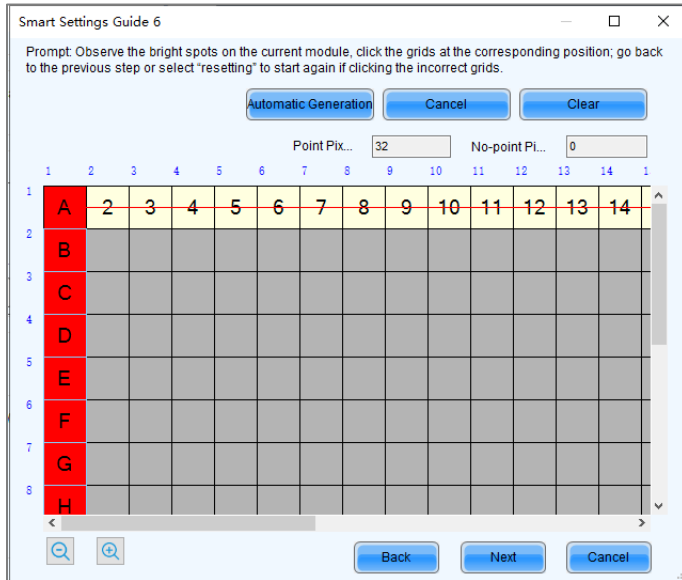
Step 11 Click **Next** and click **OK**.

Step 12 (Optional) Enter a module name and save the module configuration as a file or save the module configuration to the cabinet database.

In the future, you can load the module configuration file to quickly light the modules with the same specifications.

- Browse: Select the path to save the module configuration file.
- Change Cabinet Database: Open or create a cabinet database.
- View: View the module configuration file saved in the cabinet database.
- View Module: View the detailed information about the current module.

Figure 5-20 Saving module information

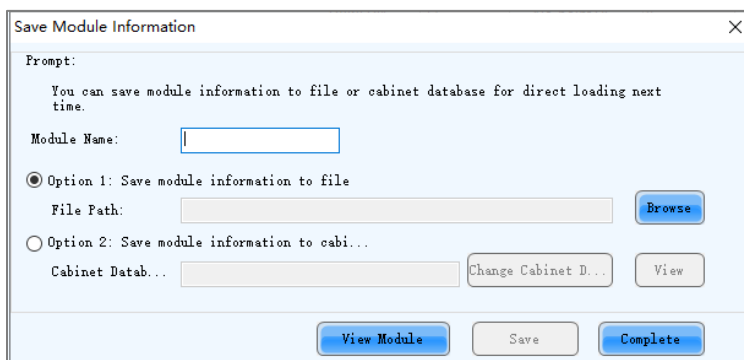

Step 13 Click Complete.

Notes

On the **Receiving Card** tab page, you can also perform the following operations.

- In the **Module Information** area, click  to view the detailed module information. On the **Details of Module** page, click **Save Module** to save the module configuration as a file.
- Click **Restore Factory settings** to reset the configuration information of all or specified receiving cards to factory settings.
- Type "admin" to show the **Save to factory area** button. This button is used to save some parameters to the factory area before delivering the cabinets to users. This function is supported only by some receiving cards.

5.2.2.2.2 Set Cabinet

Applications

Set the size of the cabinet loaded by the current receiving card and the cascading direction of the modules in the cabinet.

Applicable Products

All receiving cards

Prerequisites

- A module is lighted. For details, see 5.2.2.1 Light Module.
- If the cabinet is irregular, the cabinet database file (.mcl) or module configuration file (.module) is prepared.

Related Information

If a cabinet is rectangle and the specifications of all the modules are the same, the cabinet is a regular cabinet, otherwise it is an irregular cabinet. For an irregular cabinet, the configuration file must be used to construct the cabinet.

Operating Procedure

Step 1 On the **Screen Configuration** page, click the **Receiving Card** tab.

Step 2 In the **Cabinet Information** area, perform the corresponding operations below based on the cabinet type.

Figure 5-21 Cabinet information

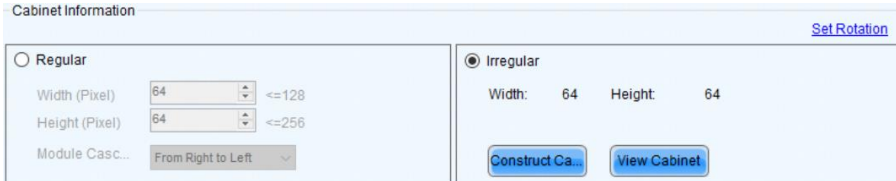

✦ Configure regular cabinet

Select **Regular**, set the cabinet width and height, and set the cascading direction of modules.

✦ Configure irregular cabinet

- If you need to configure row extraction position, select **Big Control Mode**. If **Big Control Mode** is not displayed or you do not need to configure row extraction position, skip this step.
- Select **Irregular**, click **Construct Cabinet** to open the dialog box shown in [Figure 5-22](#).
- If you have a cabinet configuration file (.mcl/.cabinet), click **Load** to configure the cabinet quickly. If you do not have the file, perform the subsequent operations to manually configure the cabinet.
- Set **Data Groups of Cabinet** according to the number of data groups actually used by the cabinet and click **Set**.
- Click **From Cabinet Database** or **From File** to load modules.

When loading modules from files, you can set the numbers of module rows and columns. The loaded modules support the **Ctrl+C**, **Ctrl+V**, **Ctrl+A**, **Delete**, **Ctrl+Z** and **Ctrl+Y** keyboard shortcuts.

- f. Adjust the positions of modules to let them form a cabinet whose size is consistent with the actual cabinet size.

You can adjust the module positions by directly dragging the modules or using the functional buttons in the **Module Alignment** and **Module Spacing** areas. Currently, the position adjustment operations cannot be undone.

- g. Select the data group one by one and double click the corresponding modules to connect them.

When selecting the data group, you can click the **A** key or **D** key on the keyboard to switch data groups.

After you double click the module, the module number is displayed. For example, (2, 2) indicates the module is the second module of the second data group. Right clicking the module can cancel the connection.

Functions in the **Quick Operation** area allow you to quickly number the selected modules and you do not need to select data group first. The module positions after numbering may change and you can adjust them if necessary.

- h. Select **Simple Mode** or **Advanced** and configure one or more row extraction positions. If **Big Control Mode** is not selected on the **Receiving Card** tab page, skip this step.

Simple Mode: Set the row extraction position of cabinet and click **Add**. For example, if you set the parameter to **2**, the second row in the cabinet will be extracted during row extraction and the second column will be extracted during column extraction.

Advanced: Set the row extraction position of module and click **Add**. For example, if you set the three parameters to **2**, the second row in the second cascaded module connected to the second data group will be extracted during row extraction and the second column in the second cascaded module connected to the second data group will be extracted during column extraction.

- i. After the configurations are done, click **OK**. If necessary, click **Save** to save the cabinet configuration information to the cabinet database or save the information as a file.
- j. (Optional) Click **View Cabinet** to view the cabinet information.

Figure 5-22 Constructing irregular cabinet

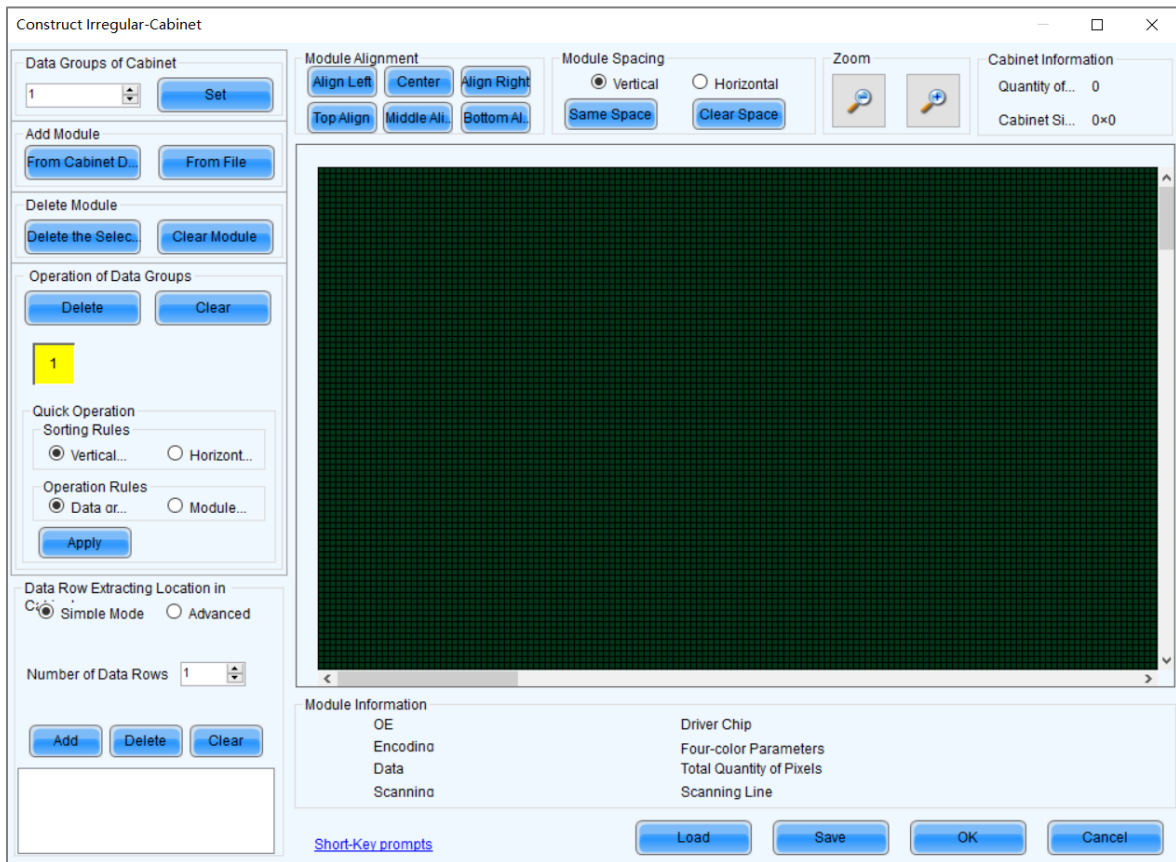

Step 3 If cabinet rotation is required, click **Set Rotation** and select the rotation angle. If it is not required, skip this step.

After cabinet rotation is set, all the input sources will be rotated to display according to the set angle.

- Step 4 After the settings are done, click **Send to Receiving Card**. In the displayed dialog box, select **All Receiving Card** or specify receiving cards, and click **Send**.
- All Receiving Card: Send the receiving card configuration information to all the receiving cards loaded by the current sending card. If you select **Reset the Starting Coordinate of Receiving Card**, the starting coordinates of all the receiving cards will be reset to (0, 0). As a result, all the receiving cards display the top-left image of the input source.
 - Specify Receiving Card: Send the receiving card configuration information to the specified receiving cards by topology or by physical address.

Figure 5-23 Sending parameters to receiving card

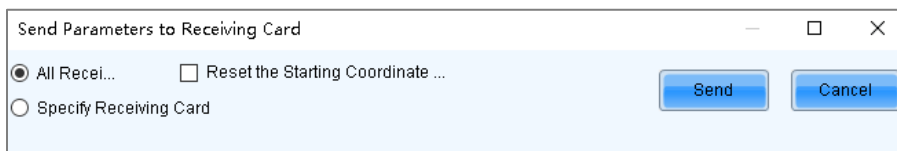

- Step 5 After successful sending, click **OK** to close the prompt box. The screen is now lighted.
- Step 6 (Optional) Click **Save to File** to save the configuration information as a receiving card configuration file (.rcfgx), or click **Receiving Card is configured with U disk file** to save the information as a USB drive file (.bin).

5.2.3 Step 3 Connect Screen

Applications

Connect the receiving cards logically. Generally, one receiving card loads one cabinet. Therefore, this function is also called connecting cabinets.

Applicable Products

- Configuration of standard screen: Applicable to all sending cards
- Configuration of complex screen: The DVI connector of the MCTRL1600 cannot be used to configure a complex screen. You must use its DP 1.2 connector. The E8000 cannot be used to configure a complex screen.

Prerequisites

None

Related Information

In NovaLCT, you can configure up to 20 screens.

To configure a complex screen efficiently, you are advised to configure a standard screen first and then configure the complex screen based on the standard screen.

Operating Procedure

- Step 1 On the **Screen Configuration** page, click the **Screen Connection** tab.
- Step 2 Set the screen quantity and click **Configure**.
- If the multiple output ports of the sending card load the different areas of the same screen, set the screen quantity to **1**. If the multiple output ports of the sending card load different screens, set the screen quantity to the number of screens loaded.
- Step 3 On the **Standard Screen** page, set the column and row quantity of receiving cards. For example, set them to 10 columns and 5 rows respectively, as shown in [Figure 5-24](#).

Figure 5-24 Column and row quantity of receiving cards

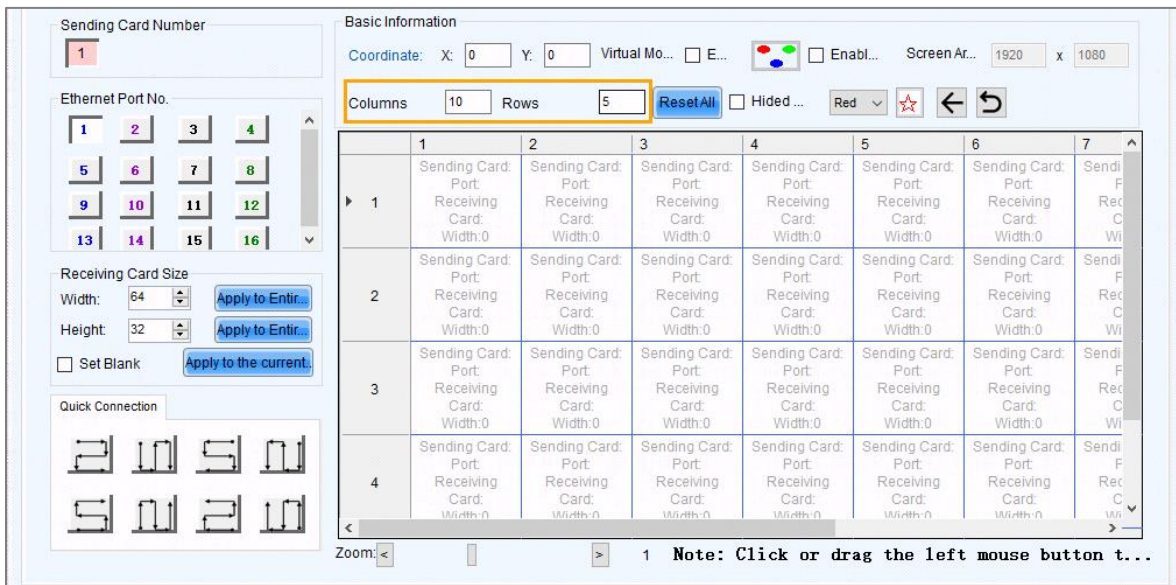

Step 4 Choose an output port.

Step 5 Set the receiving card size (loading capacity) and connection. For example, Figure 5-25 illustrates setting of the receiving cards loaded by output port 1.

- Custom connection: In the table, click or drag the mouse.
- Quick connection: Click a connection pattern and drag the mouse to select an area in the table.

During connection, the loading capacity of all the receiving cards is the value you set by default. If necessary, you can change the width and height of the loading capacity on the left.

Right clicking a receiving card cancels the configuration of the card.

Figure 5-25 Receiving card connection and size

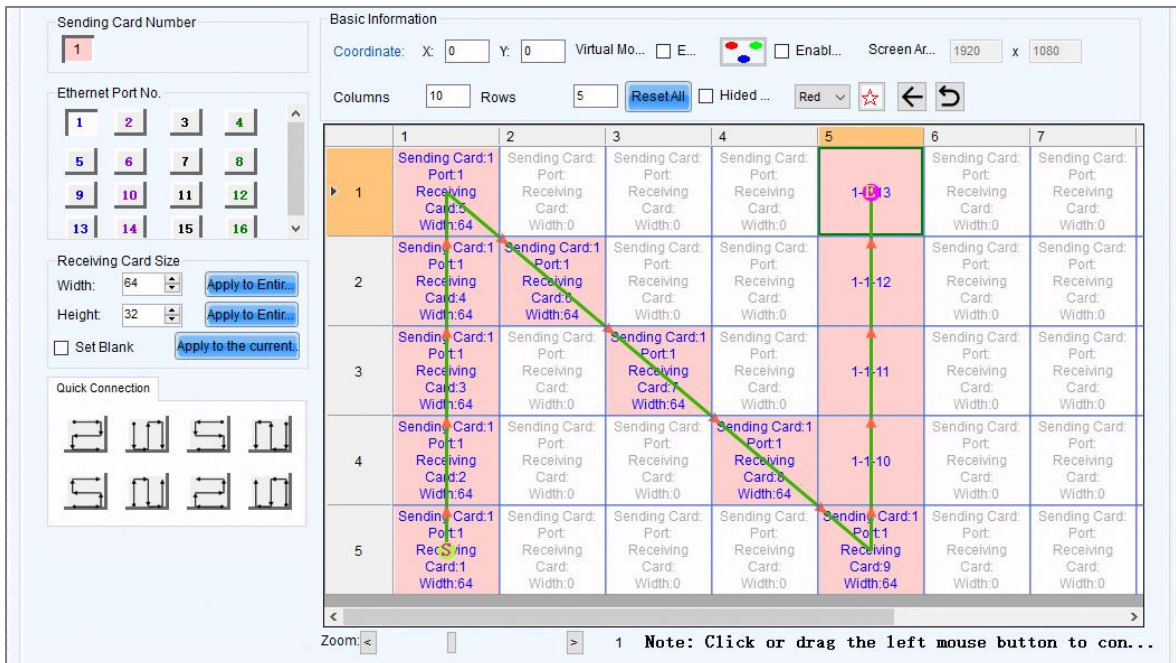

- Apply to Entire Column: Apply the loading capacity width of the selected receiving card to all the receiving cards in the same column.
- Apply to Entire Row: Apply the loading capacity height of the selected receiving card to all the receiving cards in the same row.
- Apply to the Current Port: Apply the current loading capacity width and height to all the receiving cards connected to the current output port.
- Reset All: Reset all the receiving card connections and blanks.

- Hidden Mapping Line: Hide the receiving card mapping line (namely the connections).
- ☆: Mark the receiving card.
- ⬅: Return to the previous step of connection.
- ↺: Clear all the connections of receiving cards connected to the current output port.
- Zoom: Zoom in or out the receiving card interface in the middle. When the interface is large enough, cabinet related information is displayed.

Step 6 Set the specified receiving cards blank and set the blank size, as shown in the example in Figure 5-26. If you do not need to set blank, skip this step.

Click a receiving card and select **Set Blank** to leave the position of that receiving card blank. Continue clicking or dragging the mouse on the empty cabinets to set blank on the other positions.

The receiving cards that are left blank do not load the screen to display the image, which helps to realize configuration of complex screen.

The blank size must be set based on the loading capacities of the neighbor receiving cards. For example, the display effect of both connection lines in Figure 5-27 is N shape. The areas in red boxes are loaded by the neighbor receiving cards. Therefore, their blank size is set to 0.

Figure 5-26 Setting receiving card blank

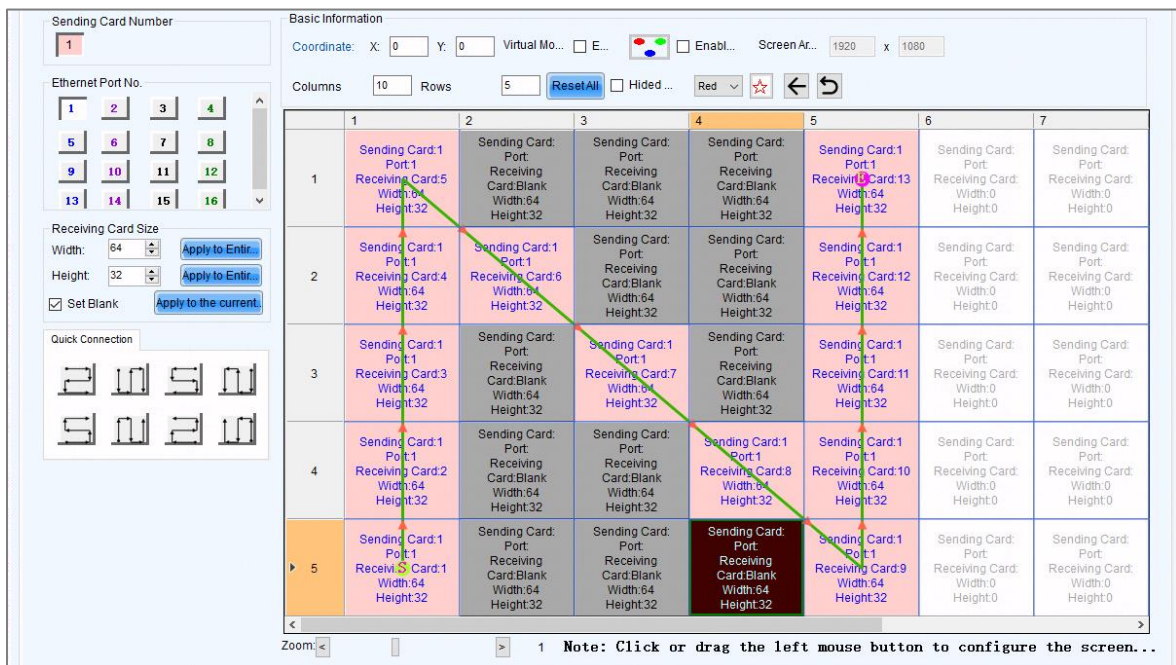

Step 7 Repeat Step 4 to Step 6 to set the receiving cards loaded by the other 6 output ports.

For example in Figure 5-27, the receiving cards connected by the green line are loaded by output port 1 and the receiving cards connected by the yellow line are loaded by output port 2.

Figure 5-27 Configuration completed

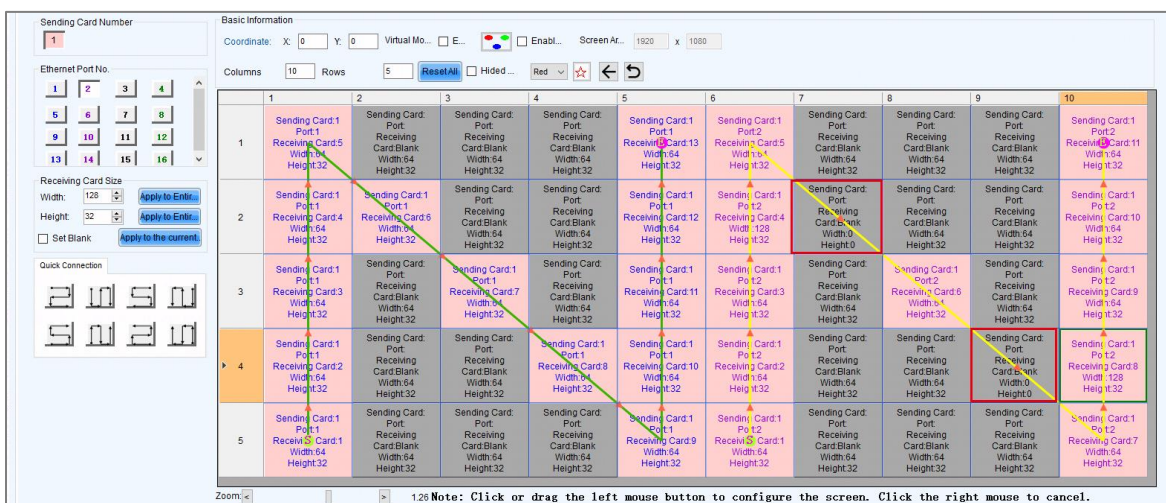

Notes

To configure a complex screen efficiently, you are advised to configure a standard screen first and then configure the complex screen based on the standard screen by following the operations below.

After the standard screen is configured, select **Complex Screen**. The **Complex Screen** page shows the connection diagram of the standard screen. The connection diagram in Figure 5-26 is shown as the diagram in Figure 5-28.

You can directly drag cabinets on the left or adjust data in the table on the right to let the configuration meet the actual screen configuration requirements.

Figure 5-28 Configuration of complex screen

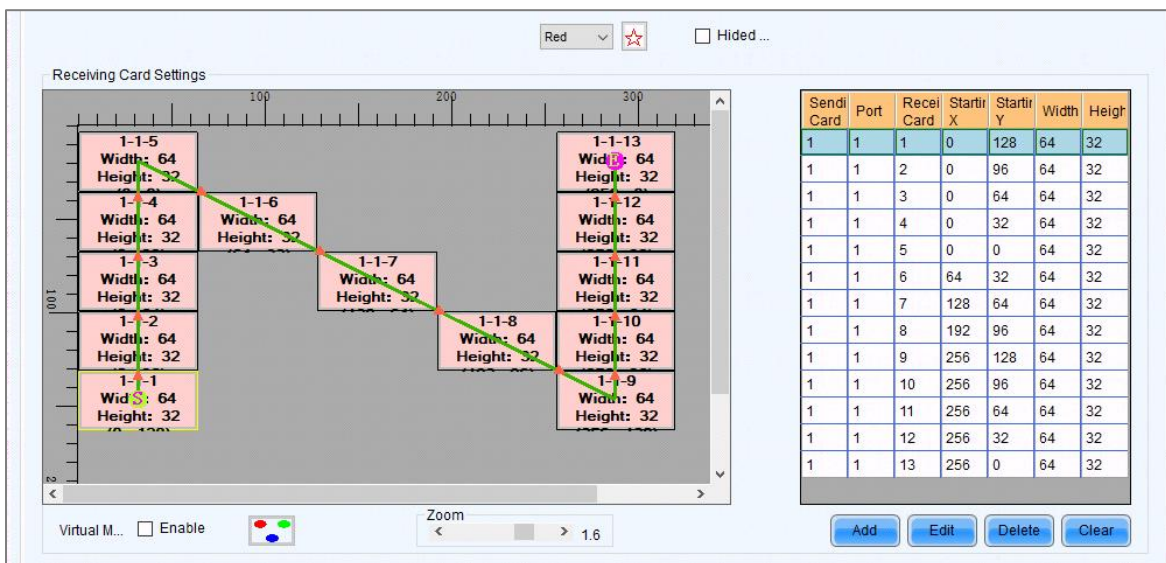

Step 8 Click **Send to HW** to send the configuration information to the hardware. If necessary, click **Save to File** to save the configuration information as a file.

Empty cabinets cannot exist before saving configuration. You can set the empty cabinets blank.

Step 9 After the settings are done, click **Save** to save the configuration information to the hardware.

Step 10 After successful saving, choose whether to save the backup file to the local computer.

When the control computer can access the Internet, you can use the backup file to register screens to VNNOX Care. For details, see 7.1.2.1 Register by Using Local Backup Files (Recommended).

This step is related with the configuration of the save function. See 11.1 Configure the Save Function.

Figure 5-29 Successful saving

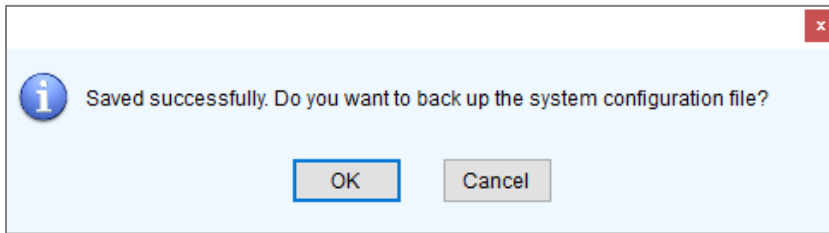

Related Operations

- Detect Communication Status: Detect the status of connection between the receiving card and Ethernet port.
- Read the Number of Receiving Cards: Read the number of receiving cards connected to the current Ethernet port.
- Enable Mapping: Enable the Mapping function. The Mapping function is for you to obtain the receiving card connection information conveniently.
- Read from HW: Read the current configuration information in the hardware.
- Coordinate: Set the start position of the display image on screen.
- Virtual Mode: For modules with shared pixels (sub-pixels), you can check the **Enable** checkbox and then click  to set the parameters for virtual pixels.

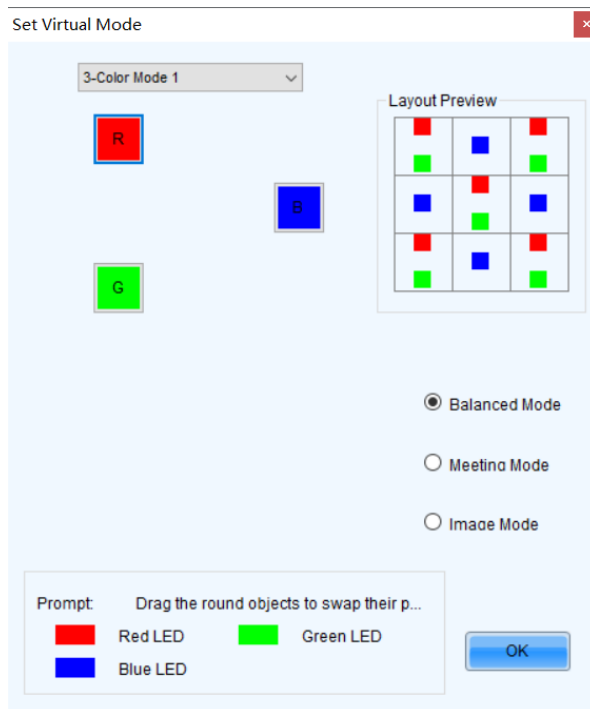

- Balanced Mode: Suited for standard display scenarios.
- Meeting Mode: Suited for displaying documents.
- Image Mode: Suited for displaying images and videos.
- Enable Sync: Used for the mosaic function of the all-in-one device
- Back Up System Configuration: Back up some system configurations, sending card configurations and receiving card configurations to the local computer. This button is available for the MCTRL660 PRO device only.
- Restore System Configuration: Use the backup file (.pbk) to restore the system configurations, sending card configurations and receiving card configurations. This button is available for the MCTRL660 PRO device only.

5.2.4 Step 4 (Optional) Save Configuration Files

Applications

After the screen configuration is done, save the configuration file of the online screen to the cloud (VNNOX Care) and the local computer, or save the configuration file of the offline screen to the local computer.

Applicable Products

All receiving cards and sending cards

Prerequisites

To save the configuration files to the cloud, the following conditions must be met:

- You have a valid VNNOX Care account.
- The control PC is connected to the Internet.

Related Information

When saving the configuration files of a screen that is not registered with the cloud, the screen will be registered with VNNOX Care automatically. During registration, NovaLCT will automatically enable **Automatic Refresh** and **Link to NovaiCare** in the monitoring configuration. If you want to set the refresh period, please see [7.2 View and Configure Monitoring](#).

The configuration files saved to the cloud include the receiving card configuration file (.rcfgx), screen connection file (.scr), version file (.cfg), etc. The version file contains the version information about NovaLCT and the receiving card program package.

The configuration files saved to the local computer include the system configuration file (.scfg) only.

Operating Procedure (Online Screens)

- Step 1 On the **Screen Configuration** page, click **Save System Configuration File** to open the dialog box shown in [Figure 5-30](#).

Figure 5-30 Saving configuration files (online screen)

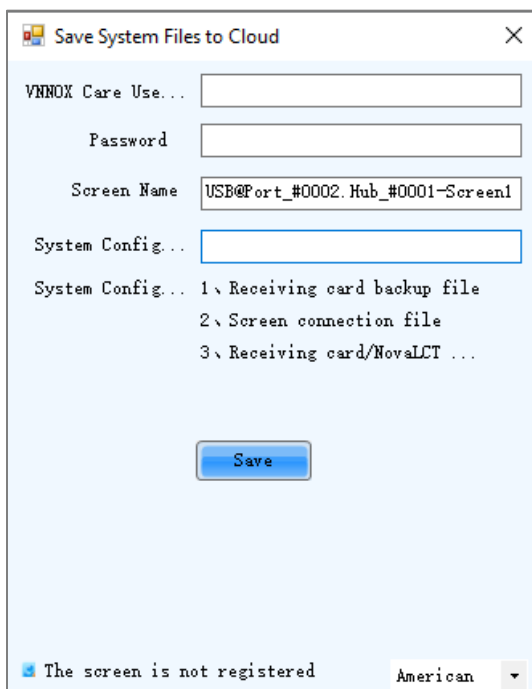

- Step 2 Enter your VNNOX Care user name and password, set the screen name and system configuration file name, and select a server node.
- Step 3 After the parameter settings, click **Save**.
- Step 4 After successful saving, close the prompt box.

Operating Procedure (Offline Screens)

- Step 1 On the **Screen Configuration** page, click **Save System Configuration File** to open the dialog box shown in [Figure 5-31](#).

Figure 5-31 Saving configuration files (offline screen)

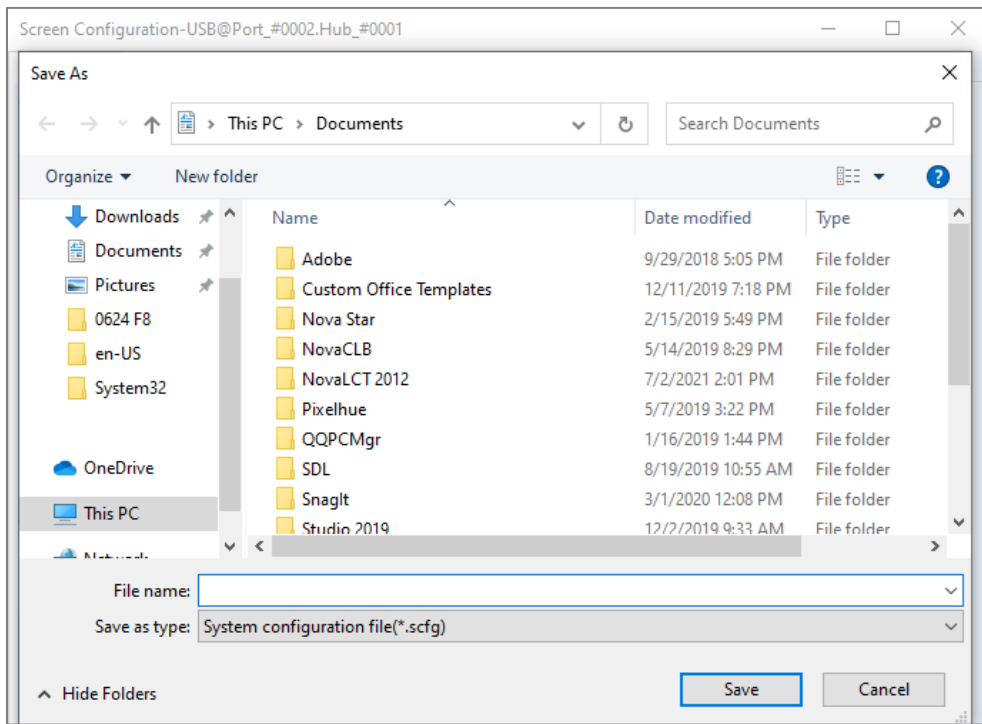

- Step 2 Select a location from the control PC and click **Save**.
- Step 3 After successful saving, click **OK** to close the prompt box.

5.3 Set Redundancy

Applications

Set device redundancy and Ethernet port redundancy to ensure high reliability of the control system in applications like stage and conference center.

Applicable Products

- Redundancy: Applicable to all sending cards
- Hot backup verification: Applicable to the MCTRL4K, MCTRL R5 and KT8 sending cards

Prerequisites

Redundancy related hardware connection is done. The devices are cascaded before you set device redundancy and Ethernet port redundancy between devices.

Related Information

Use the hot backup verification function to directly verify effectiveness of backup Ethernet ports without disconnecting and reconnecting Ethernet cables.

Operating Procedure

- Step 1 On the menu bar, choose **User > Advanced Synchronous System User Login**. Enter the password and click **OK**.
The default password is “admin”.



- Step 2 Click **Screen Configuration** or choose **Settings > Screen Configuration** from the menu bar to open the dialog box shown in Figure 5-32.

Figure 5-32 Screen configuration method

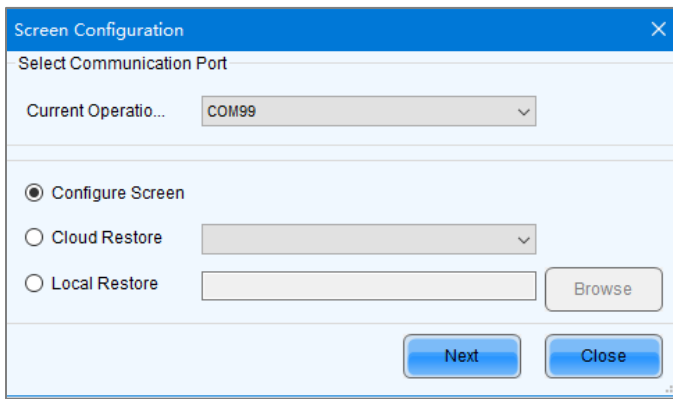

Step 3 Choose a communication port.

Step 4 Select **Configure Screen** and click **Next**.

Step 5 On the **Sending Card** tab page, perform any of the following operations as required.

+ **Configure device redundancy**

- Set a single device

Select **Set as Primary** or **Set as Backup** to set the current device as the primary or backup device.

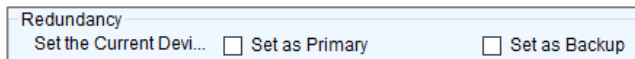

- Set multiple devices

Click **Set** in the **Redundancy** area to open the **Redundancy settings** dialog box. Then, select **Set as Primary** or **Set as Backup**. At last, select the sending cards you want to set and click **Set**.

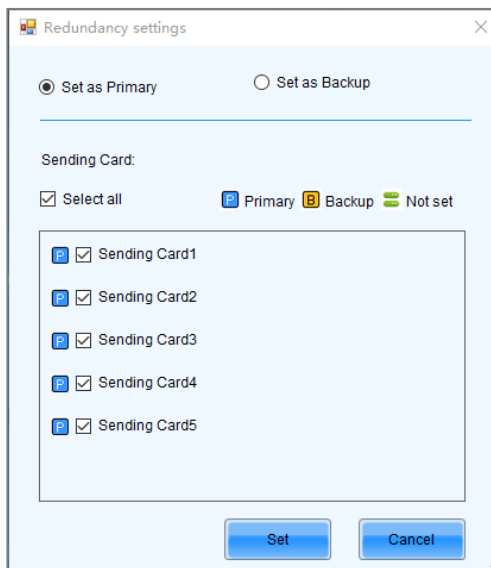

Notes

To set a single backup device as the primary device, deselect **Set as Backup** first, send the settings to the hardware and then select **Set as Primary**.

The sending card that is used in the completed screen configuration cannot be set as backup device. To set it as backup device, you must delete the screen configuration information first.

+ **Configure Ethernet port redundancy**

- Click **Add** to open the **Redundancy Settings** dialog box.



- b. Enter the serial numbers of the sending cards and output ports, and click **Add**.
For Ethernet port redundancy within a sending card, enter the same value for serial numbers of the primary and backup sending card. For Ethernet port redundancy between sending cards, enter the actual serial numbers of the primary and backup sending cards after they are cascaded.
- c. After the configurations are done, click **Close**.

Step 6 (Optional) After Ethernet port redundancy is configured, perform the following operations to verify hot backup.

1. Click **Verify** to open the dialog box shown in [Figure 5-33](#).
2. Select the sending card and click **Enable Hot Backup Verification**. If the display is normal, the backup Ethernet port is effective, otherwise it is not.
3. After verification, click **OK**.
4. Click **Disable Hot Backup Verification** and click **OK**.
5. Close the **Hot Backup Verification** dialog box.

Figure 5-33 Hot backup verification

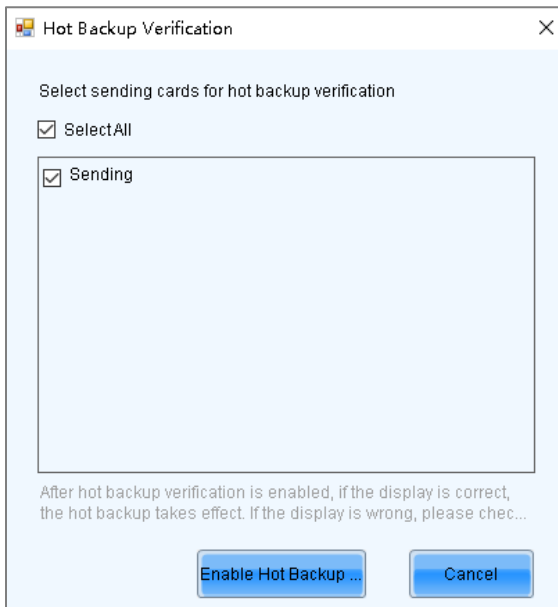

Step 7 Click **Send** to send the configuration information to the hardware, or click **Save** to save the information to the hardware.

Step 8 After successful saving, choose whether to save the backup file to the local computer.

When the control computer can access the Internet, you can use the backup file to register screens to VNNOX Care. For details, see [7.1.2.1 Register by Using Local Backup Files \(Recommended\)](#).

This step is related with the configuration of the save function. See [11.1 Configure the Save Function](#).

Figure 5-34 Successful saving

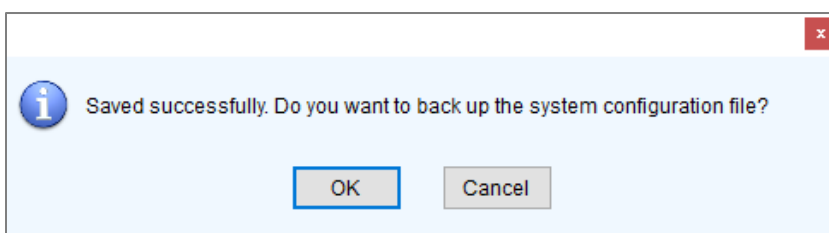

5.4 Enable 3D

Applications

Enable the 3D function and set the related parameters to let users wearing 3D glasses enjoy stereoscopic images.

Applicable Products

The MCTRL4K, MCTRL1600, KT8, KT8E, KT16E, KT16C, MEE200 and MEE400 sending cards, and H series products

Prerequisites

The 3D and low latency functions cannot be enabled at the same time. The low latency function must be disabled before enabling 3D function.

The hardware connection is done and the 3D glasses are prepared.

Related Information

After the 3D function is enabled, the loading capacity of the sending card is reduced by half.

Operating Procedure

- Step 1 On the menu bar, choose **User > Advanced Synchronous System User Login**. Enter the password and click **OK**.
The default password is "admin".

- Step 2 Click  or choose **Settings > Screen Configuration** from the menu bar to open the dialog box shown in [Figure 5-35](#).

Figure 5-35 Screen configuration method

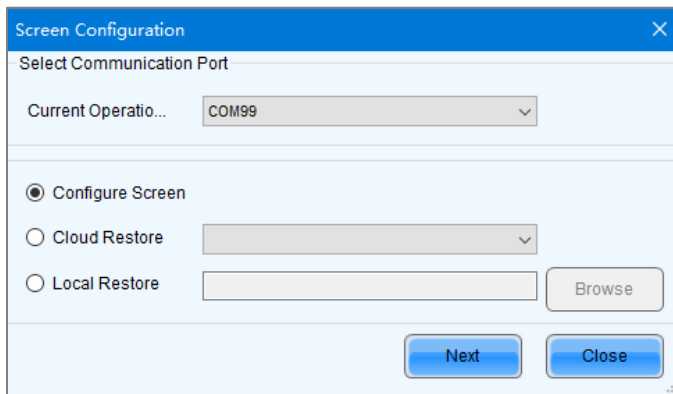

- Step 3 Choose a communication port.
- Step 4 Select **Configure Screen** and click **Next**.
- Step 5 On the **Sending Card** tab page, select **Enable** in the **3D Function** area.

Figure 5-36 Enabling 3D

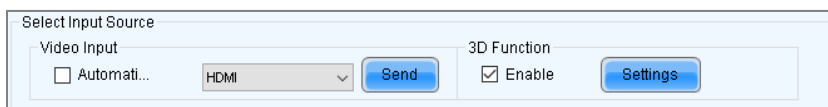

- Step 6 Click **Settings** next to **Enable** to open the dialog box shown in [Figure 5-37](#).

Figure 5-37 Setting 3D parameters

Step 7 Click **Load from File** to quickly configure the related parameters, or configure them manually.

- Video Source Format: Set the format of the video source to side-by-side, top-and-bottom or frame sequential according to the format of the used video source.
- Eye Priority: Set which image is sent first, the left eye image or the right eye image. Wear the 3D glasses and watch the display. If the display is abnormal, set the parameter value to the other one. If the display is normal, the setting is done.
- Mode Selection: Select the same or different signal sources for the left and right eye images. If there is only one input source, this parameter is not displayed.
- Right Eye Start: Set the start position of the right eye image. When the video source format is side-by-side or top-and-bottom and the left and right eye images are provided, this parameter can be set.
- 3D signal emitter: If you use a third-party 3D emitter, select **Enable third-party emitter**. If you use the EMT200 emitter of NovaStar, do not select it.
- Signal Delay Time: Set the delay time of sending the synchronization signal from 3D signal emitter to the 3D glasses. This setting ensures that the switching between left and right eye images of the 3D glasses is in sync with the switching between the left and right images on the display. This parameter is applicable to both the NovaStar and third-party emitters.

Step 8 After the configurations are done, click **Save** to save the configuration information to the hardware.

The 3D parameters take effect on the hardware immediately after they are configured. If they are saved to the hardware, they will not be lost even after the device is powered off.

Step 9 (Optional) Click **Save to File** to save the configuration information as a file on the local computer.

5.5 Set Working Mode

Applications

Set the working mode to let the device switch to the sending card mode (also known as video controller mode) or the fiber converter mode.

Applicable Products

The MCTRL660 PRO, MCTRL1600, H9, NovaPro UHD Jr, K16, and MCTRL R5 sending cards

Prerequisites

None

Related Information

For the MCTRL1600, H9, NovaPro UHD Jr and K16, after their working mode is set to sending card mode, you can further set the working mode of their optical ports. The working modes of optical port include hot backup mode and copy mode.

Figure 5-38 and Figure 5-39 are illustrations of the two optical port working modes, using the NovaPro UHD Jr as an example.

- Hot backup mode: The sending card sends the two duplicate optical signals to the same display through the primary and backup fiber converters to form a loop backup.
- Copy mode: The sending card sends the two duplicate optical signals to two displays through two fiber converters.

Figure 5-38 Hardware connection for optical port hot backup mode

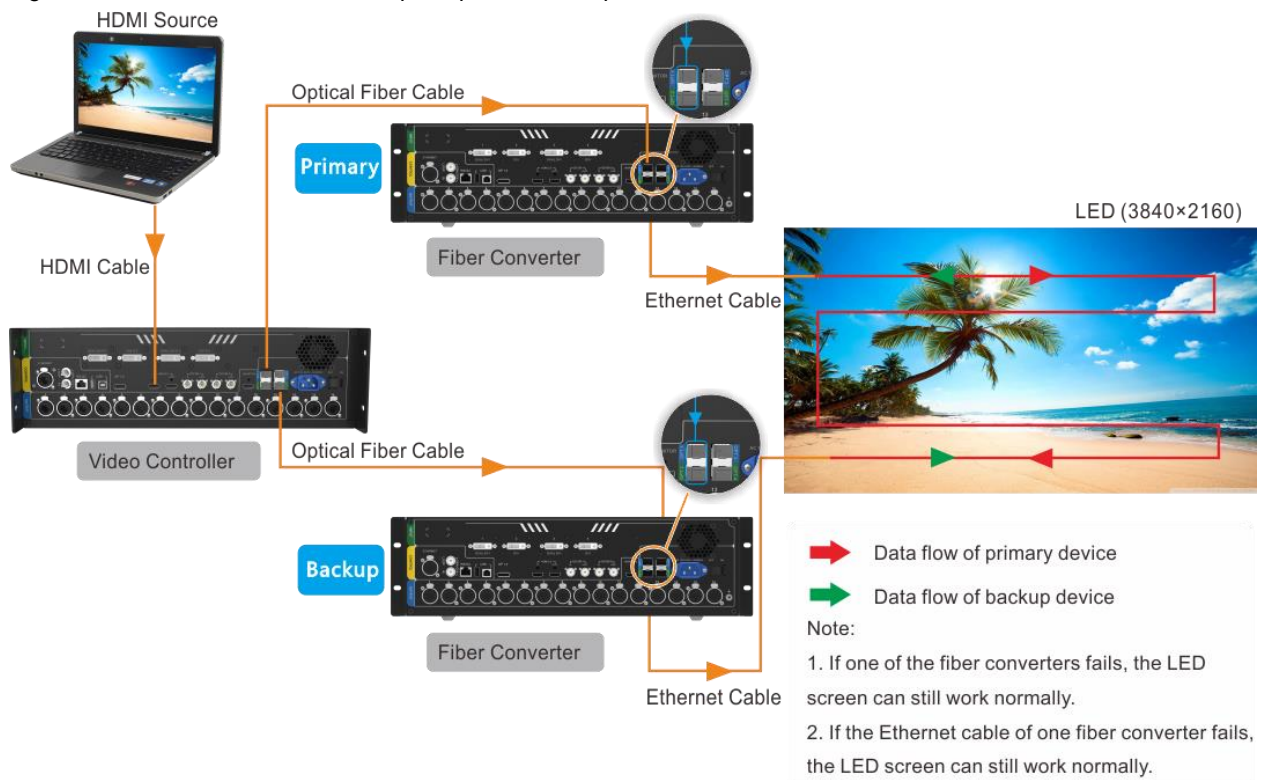
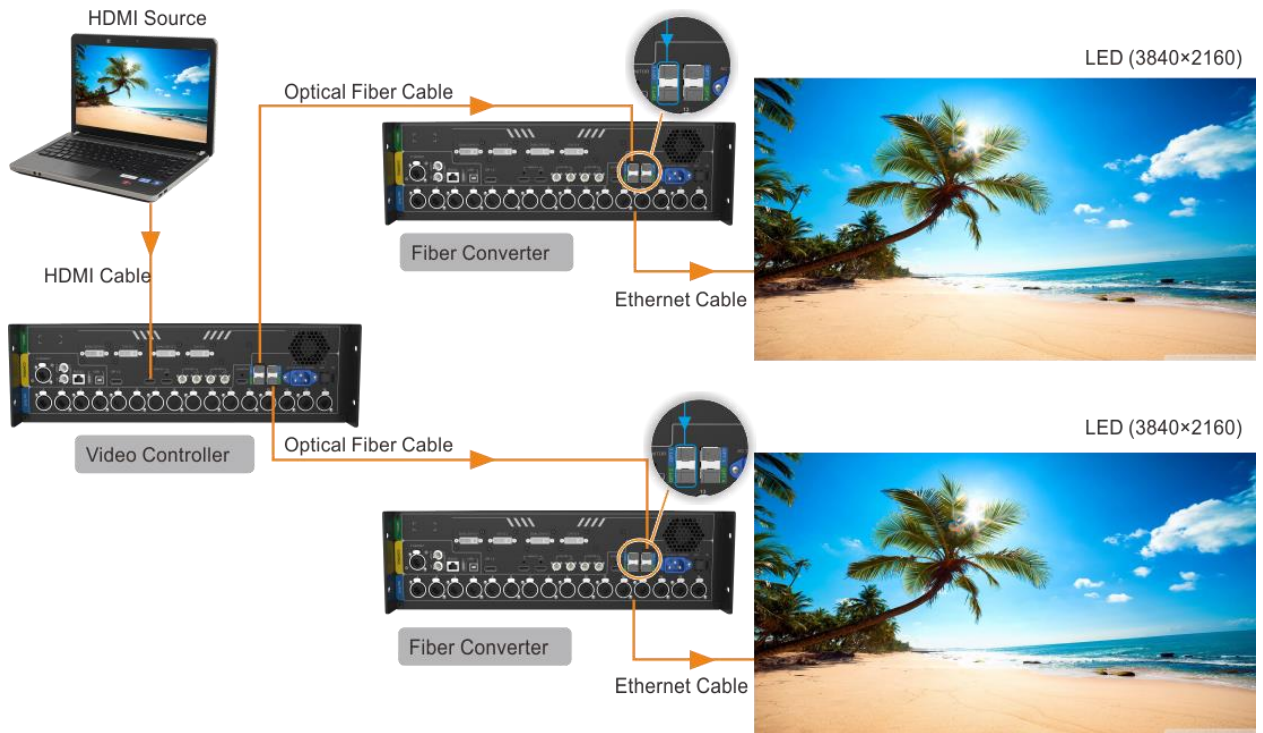

Figure 5-39 Hardware connection for optical port copy mode



Operating Procedure

Step 1 On the menu bar, choose **User > Advanced Synchronous System User Login**. Enter the password and click **OK**.
The default password is “admin”.



Step 2 Click **Screen Configuration** or choose **Settings > Screen Configuration** from the menu bar to open the dialog box shown in Figure 5-40.

Figure 5-40 Screen configuration method

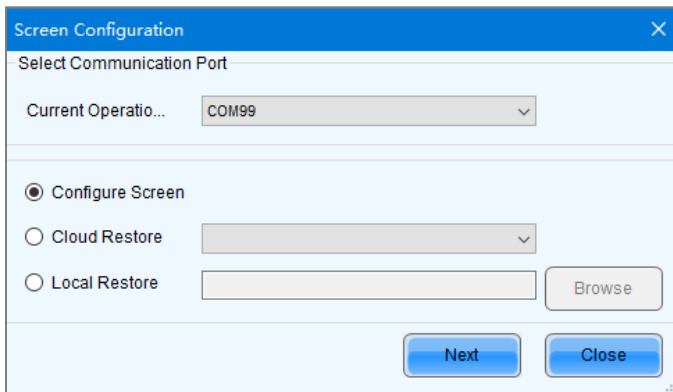

- Step 3 Choose a communication port.
- Step 4 Select **Configure Screen** and click **Next**.
- Step 5 On the **Sending Card** tab page, click **Set Working Mode**.

Figure 5-41 Working mode

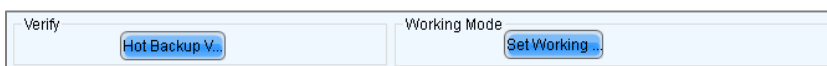

Step 6 Select the sending card and set the working mode to sending card mode or fiber converter mode.

Figure 5-42 Setting working mode

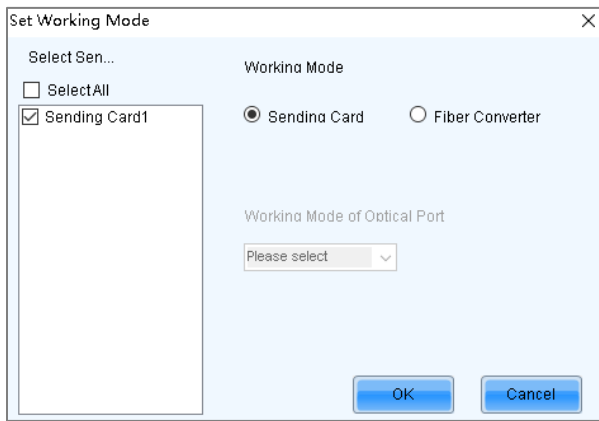

Step 7 For the MCTRL1600, H9, NovaPro UHD Jr and K16, after their working mode is set to sending card mode, if necessary, set the working mode of their optical ports.

Step 8 Click **OK**.

5.6 Enable Zoom

Applications

Enable the zoom function and set the output resolution to let the image be displayed in a specified size.

Applicable Products

The KT8E, KT16E, KT16C, MEE200 and MEE400 sending cards

Prerequisites

None

Related Information

None

Operating Procedure

Step 1 On the menu bar, choose **User > Advanced Synchronous System User Login**. Enter the password and click **Login**.

The default password is “admin”.

Step 2 Click  or choose **Settings > Screen Configuration** from the menu bar to open the dialog box shown in [Figure 5-433](#).

Figure 5-43 Screen configuration method

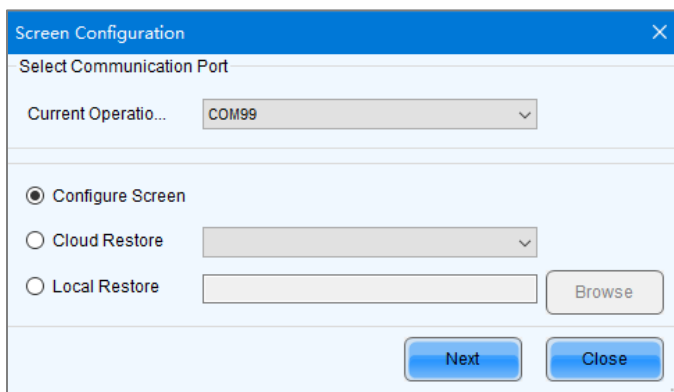

- Step 3 Choose a communication port.
- Step 4 Select **Configure Screen** and click **Next**.
- Step 5 Click the **Sending Card** tab.
- Step 6 Select **Enable zoom** and click **OK**.

Figure 5-44 Enabling zoom



- Step 7 Set the output resolution.
- Step 8 Click **Set** and click **OK**.

5.7 Set Audio Input

Applications

Set the audio input to HDMI or external audio.

Applicable Products

The sending card MCTRL2000

Prerequisites

None

Related Information

None

Operating Procedure

- Step 1 On the menu bar, choose **User > Advanced Synchronous System User Login**. Enter the password and click **OK**.
The default password is “admin”.



- Step 2 Click **Screen Configuration** or choose **Settings > Screen Configuration** from the menu bar to open the dialog box shown in **Figure 5-47**.

Figure 5-45 Screen configuration method

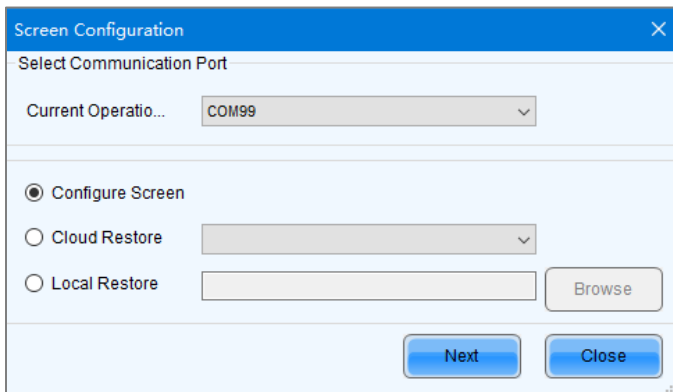

- Step 3 Choose a communication port.
- Step 4 Select **Configure Screen** and click **Next**.
- Step 5 Select the **Sending Card** tab.

Step 6 Select **HDMI** or **External Audio** from the drop-down list and then click **Send**.

Figure 5-46 Audio input

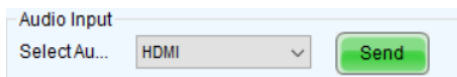

5.8 Set Performance Parameters

Applications

Set the performance parameters of the cabinet to let the screen present better display effect.

Applicable Products

All receiving cards

Prerequisites

None

Related Information

None

Operating Procedure

Step 1 On the menu bar, choose **User > Advanced Synchronous System User Login**. Enter the password and click **OK**.
The default password is “admin”.



Step 2 Click **Screen Configuration** or choose **Settings > Screen Configuration** from the menu bar to open the dialog box shown in Figure 5-47.

Figure 5-47 Screen configuration method

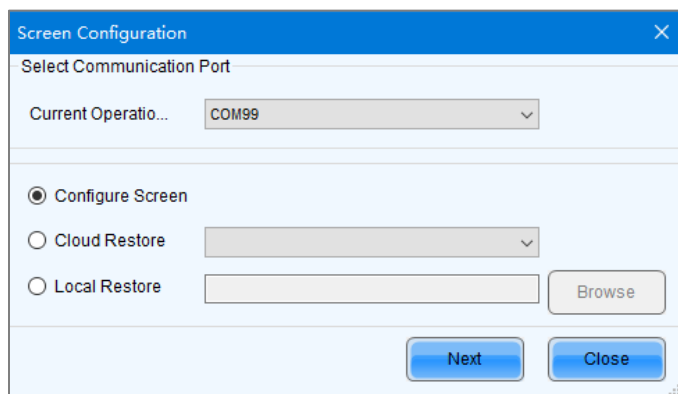

Step 3 Choose a communication port.

Step 4 Select **Configure Screen** and click **Next**.

Step 5 Click the **Receiving Card** tab and click **Read from Receiving Card** to obtain the latest configuration information.

Step 6 If you have a receiving card configuration file (.rcfgx/.rcfg), click **Load from File** to complete the configuration quickly. If do not have the file, preform the subsequent operations to manually configure the performance.

Step 7 In the **Performance Settings** area, set the performance parameters.

The screenshot shows a 'Performance Settings' dialog box with two tabs: 'Data Group E...' and 'More Settings'. The 'More Settings' tab is active. At the top right, there is a checkbox for '18bit+'. The settings are organized into two columns:

- Left Column:** Refresh Rate (480 Hz), Grayscale Level (Normal 4096), Shift Clock Fre... (12.5 MHz), Phase Position (2), Row Blanking ... (25, with a note '(=2.00us)'), Line Changing ... (3, with a note '(0~23)'), Minimum OE w... (80 ns), and Brightness Effi... (68.24%).
- Right Column:** Refresh Rate Ti... (4), Grayscale Mode (Retrefreshing Rate Fir), Duty Cycle (50, with a note '(25~75) %'), Low Grayscale C... (0), and Ghost Control En... (24, with a note '(1~24)').

The performance parameters displayed in the area varies depending on the receiving card. The main parameters include the followings.

- Refresh Rate: Indicates the rate of updating the image on the display. Increasing refresh rate reduces image flickering, allowing for a more stable image.
- Grayscale Level: Indicates the shading of display. The higher the grayscale level, the more brightness levels the display will have. For example, if the grayscale level is 16bit, the display can express 65,536 levels of brightness.
- Grayscale Mode: Indicates the grayscale display mode. It includes brightness first, refreshing rate first, grayscale first and performance balancing.
- DCLK Frequency: Indicates the frequency of shift clock.
- DCLK Duty Cycle: Indicates the duty cycle of shift clock. Set it to 50% in general.
- DCLK Phase: Indicates the phase of shift clock. When there are mismatching or flashing pixels, adjust this parameter to fix the problem.
- Refresh Rate Times: Indicates the times of refresh rate.
- Low Grayscale Compensation: Indicates the compensation for the grayscale in low grayscale conditions, allowing for more precise grayscale.
- Row Blanking Time: Used to adjust the ghost problem of the scanning type display. If the ghost problem is serious, increase the parameter value.
- Line Changing Time: Works with row blanking time to adjust the ghost of the scanning type display.
- Ghost Control Ending Time: Works with row blanking time and line changing time to adjust the ghost of the scanning type display.
- Line break trimming: Works with row blanking time to adjust the ghost of the scanning type display.
- GCLK Frequency: Indicates the frequency of grayscale clock.
- GCLK Duty Cycle: Indicates the duty cycle of grayscale clock.
- GCLK Phase: Indicates the phase of grayscale clock.
- Blanking Time Height: Used to eliminate the lower ghost
- Minimum OE Width: It is calculated from other performance parameters and can be viewed only.
- Brightness Efficiency: It is calculated from other performance parameters and can be viewed only.

Step 8 After the settings are done, click **Send to Receiving Card** to send the performance parameters to the hardware.

Step 9 After the display effect meets the expectation, click **Save** to save the performance parameters to the hardware.

Step 10 After successful saving, choose whether to save the backup file to the local computer.

When the control computer can access the Internet, you can use the backup file to register screens to VNNOX Care. For details, see [7.1.2.1 Register by Using Local Backup Files \(Recommended\)](#).

This step is related with the configuration of the save function. See [11.1 Configure the Save Function](#).

Figure 5-48 Successful saving

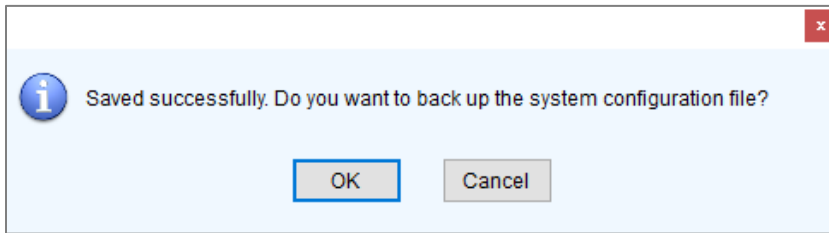

Data Group Exchange

This function is used to exchange every two data groups to adjust the display image. It can be performed only after the smart settings are done and supports regular cabinets only. For example, after you exchange the data groups A and B, data group A outputs the image of data group B, and data group B outputs the image of data group A.

Click **Data Group Exchange**, select all the receiving cards or specify one receiving card and click **OK** to open the **Data set exchange** dialog box. If the module height is less than 8 or the width is less than 20, the data group exchange is in group mode, otherwise it is in intuition mode.

The red table on the desktop indicates the original data groups. Each row is a data group. The first row is the first data group.

+ Intuition Mode

Select **Enable data exchange** and view the data group No. displayed on the screen. In the dialog box, double click the rows with the same No. in the second column and change the numbers.

Example:

The receiving card has two data groups in parallel output. The screen displays **5** and **6**, indicating that it outputs the images of data group 5 and data group 6.

In the **Data set exchange** dialog box, change **5** to **1**, **6** to **2**, **1** to **5**, and **2** to **6**, as shown in the figure below.

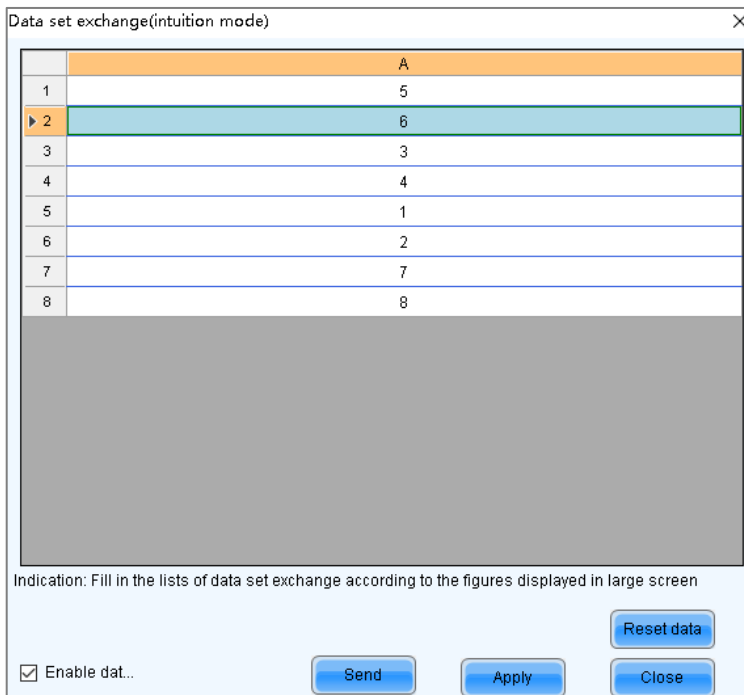

Click **Send**. The screen displays **1** and **2**, indicating that it outputs the images of data group 1 and data group 2 after data group exchange.

+ Group Mode

Select **Enable data exchange** and check whether the screen has a white area. If it has no white area, click **No flashing area**. The white row in the red table moves to the next data group. If it has a white area, click the data group you want to exchange in the **Data set exchange** dialog box.

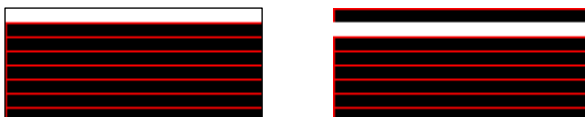

Example:

The receiving card has two data groups in parallel output. Click **No flashing area** multiple times and watch the screen. When the white row in the red table moves to the fifth data group, the screen has a white area, indicating that the screen outputs the image of data group 5.

In the **Data set exchange** dialog box, click the first data group. This exchanges data group 5 and data group 1. The white row automatically moves to the sixth data group. Then, click the second data group in the **Data set exchange** dialog box. This exchanges data group 6 and data group 2, as shown in the figure below.

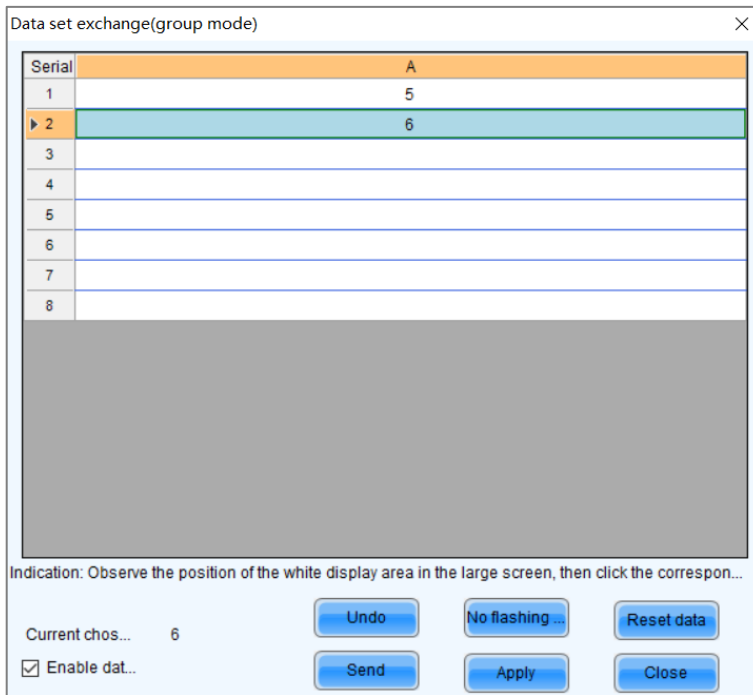

After the settings are done, click **Send** to send the configuration information to receiving cards.

More Settings

Click **More Settings** to perform the following functions and set the extended attributes for the used chip.

⊕ Symmetrical/Data Group Extension

Set the output mode of data group, data group extension, hub mode and graphics output direction.

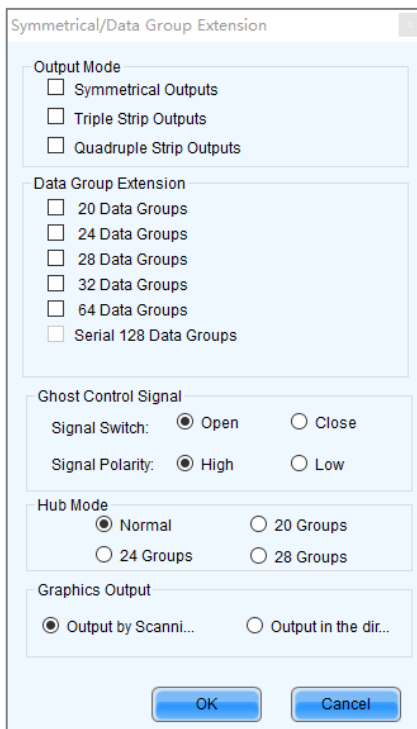

- Output Mode: If the screen is very wide and the receiving card cannot load the entire width, set the output mode to symmetrical outputs, triple strip outputs or quadruple strip outputs.

- Data Group Extension: If the receiving card supports data group extension, select the corresponding option according to the actual condition.
- Ghost Control Signal: Use the default value.
- Hub Mode: Select a mode based on the receiving card specifications.
- Graphics Output: Use the default value.

Monitoring Card Data Line Adjustment

Adjust the data lines used by red, green, blue and virtual red LEDs during LED error detection.

Select **Enable Adjustment of Monitoring Data Line** and select **Red, Green, Blue** or **Virtual Red** from the drop-down list. After the settings are done, click **OK**.

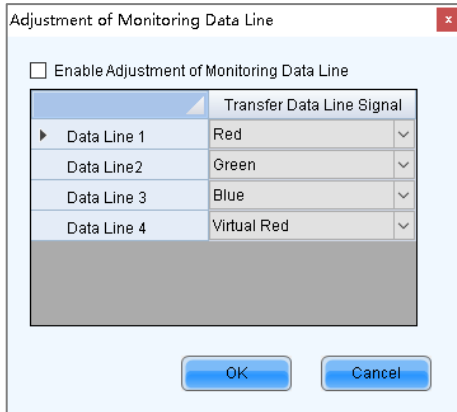

Additional Function

Enable or disable some additional functions of receiving card.

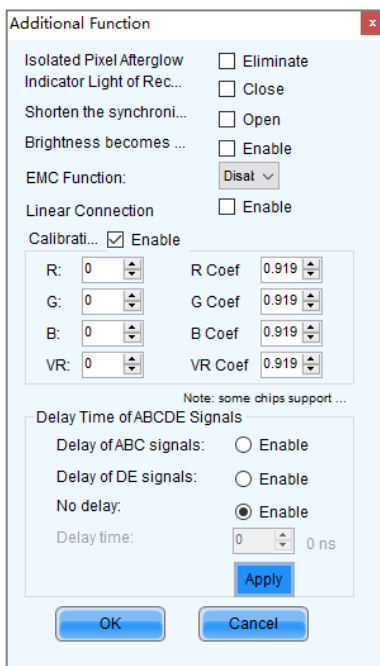

The EMC function can be set to **Disable, Weak, Medium** or **Strong**. The other functions are described as follows.

- Isolated Pixel Afterglow: Eliminate the afterglow problem of isolated pixels.
- Indicator Light of Receiving Card: Turn off the operating status indicator of receiving card.
- Shorten the synchronization time: Shorten the frame interval time during data output of receiving card.
- Brightness becomes strong slowly: Make the display become brighter slowly after the power is supplied.
- Linear: Increase the loading capacity of receiving card. The linear mode requires that the module connection line is straight, the cabinet does not have data row extraction and the cabinet is not rotated.
- Calibration Threshold: When the grayscale level is less than or equal to the specified level, use the average calibration coefficients, other than the pixel level calibration coefficients. This fixes the display problems in low grayscale after the screen is calibrated, such as mottling, color blocks and grayscale spikes.

The R, G, and B values are hexadecimal and the largest value is FFFF. Before setting them, check the Y-axis value corresponding to the X-axis value (the specified grayscale level) in the Gamma table in the brightness adjustment function, and then convert the Y-axis value to hexadecimal value. If the device does not support individual Gamma adjustment for RGB, set the R, G and B to the same value. The VR value setting is optional.

The threshold coefficient is used to determine the transition mode of pixel level calibration below the threshold value. The coefficient range is from 0.000 to 1.200, where 0 signifies no transition, rendering the pixel level calibration ineffective straightaway. The larger the value, the more gradual the decrease in effectiveness of the pixel level calibration.

- Delay Time of ABCDE Signals: Fix the problem that the afterglow cannot be eliminated because the decoding signals are not synchronized. After the settings are done, click **Apply**.

+ Flash Arrangement

When the module has a flash memory, use this function to set the flash memory arrangement of cabinet. The receiving card reads the calibration coefficients and module IDs from the flash memory via bus.

Before connecting the modules that have flash memory, obtain the bus No. A bus can cascade multiple modules. Then, set the flash arrangement according to the actual connection order.

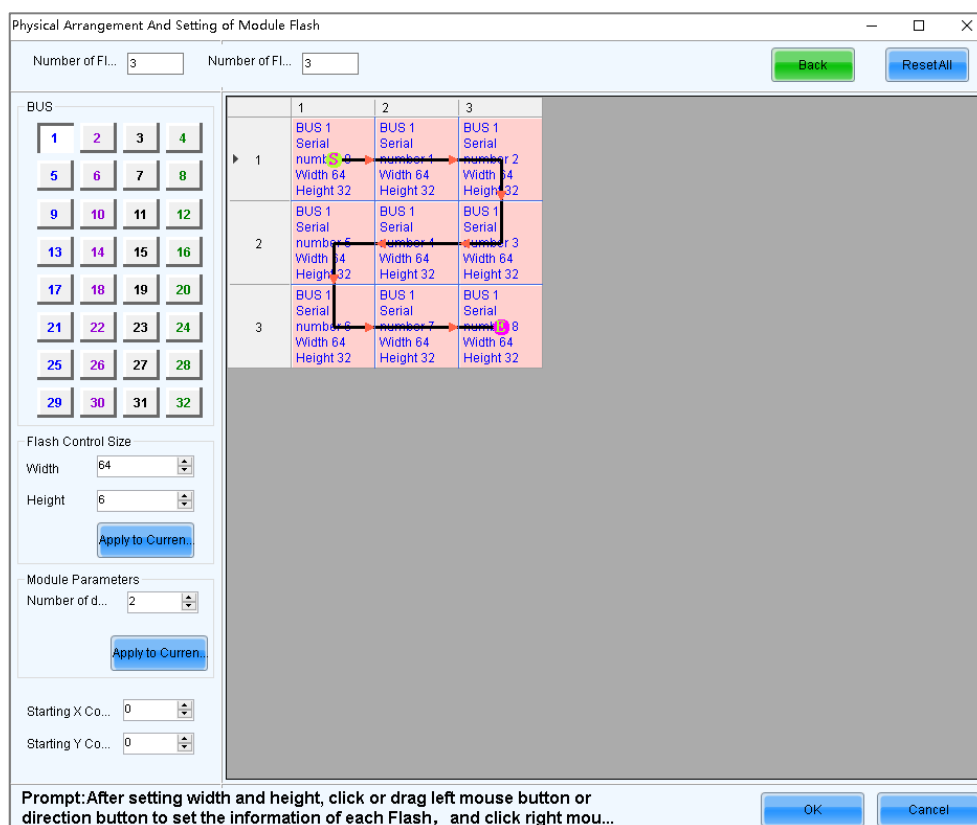

- Set the number of flash memory rows and columns. Generally, a module has one flash memory.
- Click the bus No.
- Set the width and height of the module controlled by the flash memory.
- In the arrangement table, click the cells in order according to the actual module connection.

Right clicking a flash memory cell cancels the configuration of that flash memory. Clicking **Back** returns to the previous operation. Clicking **Apply to Current BUS** sets all the flash memories connected to the current bus to the same value.

- Set the number of data groups of the module.
- If necessary, adjust the start coordinates of the flash memory, otherwise skip this step.
- If necessary, click the other bus to continue setting. After the configurations are done, click **OK**.

+ Monitoring Card Data Set Exchange

When the hardware connections of the monitoring card have errors, use this function to exchange the data groups of the card without the need to reconnect the hardware.

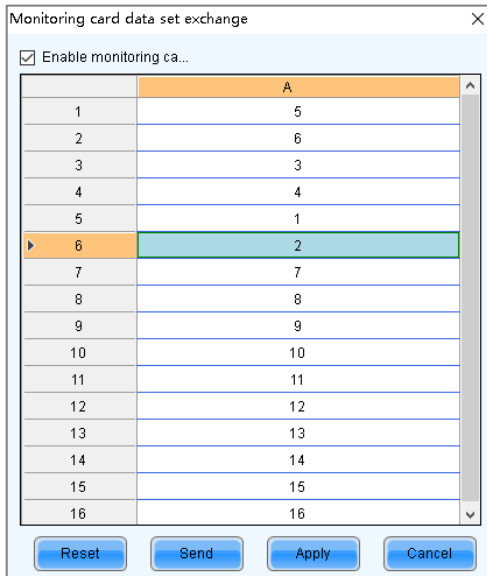

- Click **Monitoring Card Data Set Exchange**. In the displayed dialog box, select **All Receiving Cards** or specify one receiving card and click **OK**.
- In the **Monitoring card data set exchange** dialog box, select **Enable monitoring card data set exchange**.
- Double click the row in the second column and change the value. For example, change **1 to 5, 2 to 6, 5 to 1, and 6 to 2**, indicating that data group 1 is exchanged with data group 5 and data group 2 is exchanged with data group 6.
- After the settings are done, click **Send** to send the configuration information to the monitoring card.

+ **Cabinet Information Settings**

Set the weight, power, width, height, pixel width, pixel height and voltage of the cabinet base on the actual situation.

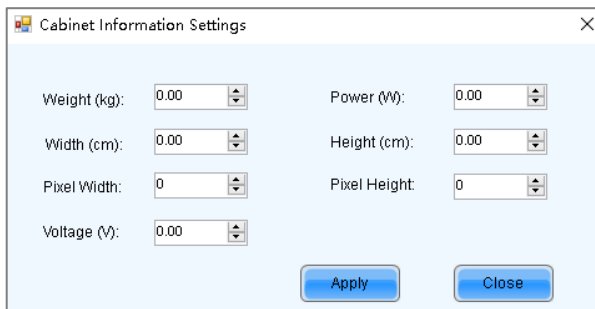

6 Brightness and Chroma Adjustment

6.1 Calibration

6.1.1 Set Online Calibration Parameters

Applications

Set parameters of displaying image and disable calibration or set calibration type during online calibration when NovaLCT works with NovaCLB calibration software.

Applicable Products

- Full-grayscale calibration: Applicable to the A10s receiving card
- Low-grayscale calibration: Applicable to the A10s receiving card
- Dark or bright line correction: Applicable to the A8s receiving card
- Other functions: Applicable to all receiving cards and sending cards

Prerequisites

- Hardware setup is done.
- NovaCLB calibration software is installed.

Related Information

Screen calibration enables the brightness and chroma of LEDs to reach target values, allowing for balanced images and better display effect.

Operating Procedure

Step 1 On the menu bar, choose **User > Advanced Synchronous System User Login**. Enter the password and click **OK**. The default password is “admin”.



Step 2 Click **Calibration** or choose **Tools > Calibration** from the menu bar.

Figure 6-1 Screen calibration

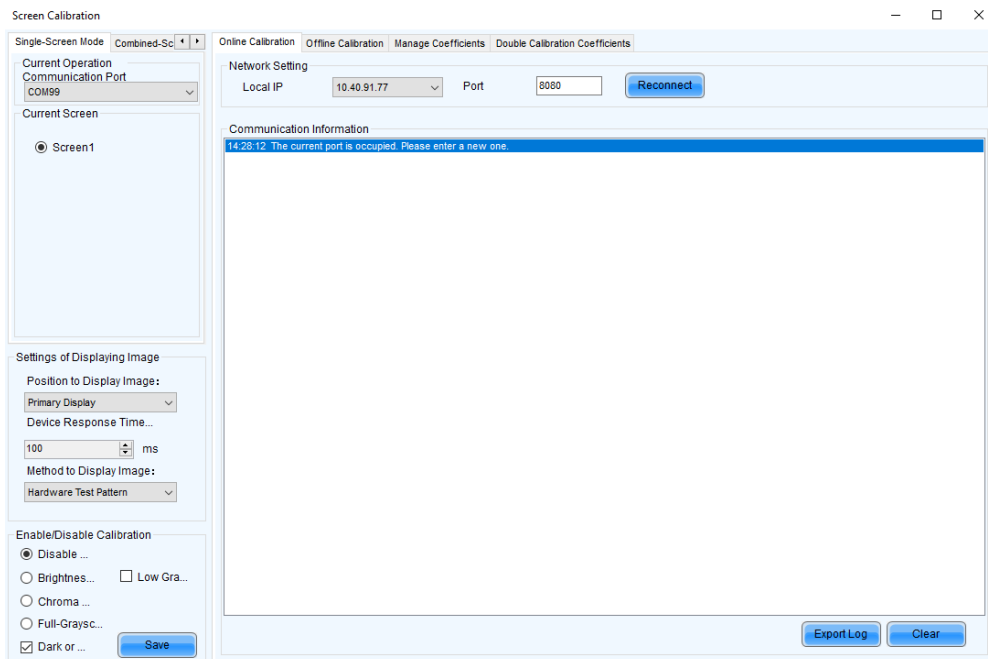

- Step 3 Select the **Single-Screen Mode** tab or **Combined-Screen Mode** tab.
- Step 4 In single-screen mode, select a communication port and screen. In combined-screen mode, skip this step.
- Step 5 Set the displayed parameters.
- Position to Display Image: Choose to display the image of the primary or extended monitor on the screen.
 - Device Response Time: In combined-screen mode, setting this parameter allows the display window to fit well with the time for camera to take pictures.
 - Method to Display Image: Select hardware test pattern or signal test pattern.
 - Enable/Disable Calibration: You can select disable calibration, brightness calibration, chroma calibration, or full-grayscale calibration. You can also select dark or bright line correction and low-grayscale calibration at the same time. Click **Save** to apply your settings.
- Step 6 If network monitoring succeeds, open NovaCLB and enter the local IP address and port number displayed on the **Online Calibration** tab page of NovaLCT to connect NovaCLB to NovaLCT.
- If network monitoring fails, click **Reconnect**, or change the port and then click **Reconnect**.
- Step 7 (Optional) Click **Export Log** to export the communication log, or click **Clear** to clear the communication log.

6.1.2 Get Average Coefficients

Applications

Get the average coefficients of a specified area on a screen.

Applicable Products

All receiving cards

Prerequisites

None

Related Information

Offline calibration is not available for combined screens.

Operating Procedure

- Step 1 On the menu bar, choose **User > Advanced Synchronous System User Login**. Enter the password and click **OK**.
The default password is "admin".
- Step 2 Click  or choose **Tools > Calibration** from the menu bar.
- Step 3 Select the **Single-Screen Mode** tab.
- Step 4 Select a communication port and screen.
- Step 5 Select the **Offline Calibration** tab.

Figure 6-2 Offline calibration



- Step 6 Specify an area where you want to get the average calibration coefficients.
- Step 7 Click **Get Average Coefficients**.
- Step 8 After the average calibration coefficients are obtained successfully, click **OK**.
- Step 9 (Optional) Click **Display** or **Hide** to show or hide the display window.

6.1.3 Manage Calibration Coefficients

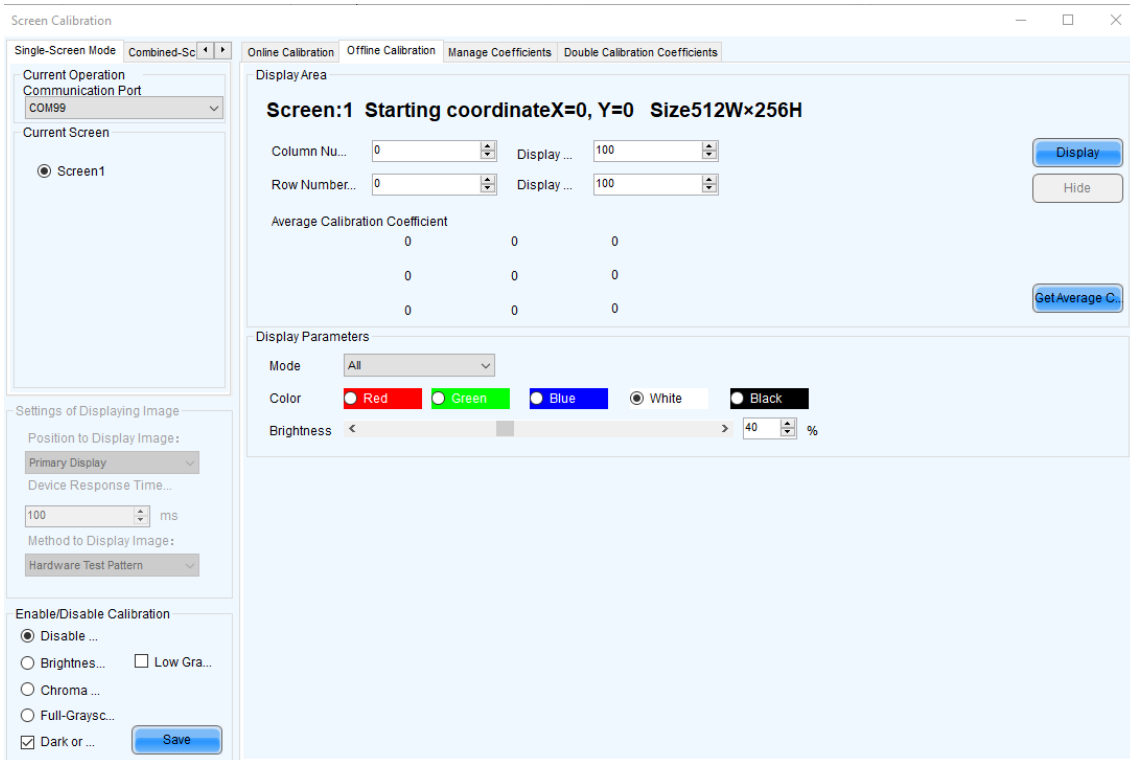
Applications

Upload, save, adjust, erase and reload calibration coefficients.

Applicable Products

- Full-grayscale calibration: Applicable to the A10s receiving card
- Low-grayscale calibration: Applicable to the A10s receiving card
- Dark or bright line correction: Applicable to the A8s receiving card
- Other functions: Applicable to all receiving cards

Prerequisites

- If you want to use a database file, you need to prepare it.
- Module flash management requires modules with flash memory.

Related Information

Calibration coefficient management is not available for combined screens.

Pixel level calibration database files fall into two types:

✦ **Screen calibration database file**

Saves the coordinates and calibration coefficients of each pixel on a screen. After the location of a cabinet is changed, the calibration coefficients cannot be uploaded to the cabinet.

✦ **Cabinet calibration database file**

Saves the coordinates and calibration coefficients of each pixel on a cabinet according to the cabinet number. After the location of a cabinet is changed, the calibration coefficients can be uploaded to the cabinet according to the cabinet number.

Module flash memory can store calibration coefficients and module IDs. In the event of network outage, you can hold down the self-test button for 2 seconds to read the calibration coefficients in module flash memory back to the receiving card.

Operating Procedure

Step 1 On the menu bar, choose **User > Advanced Synchronous System User Login**. Enter the password and click **OK**.

The default password is "admin".



Step 2 Click **Calibration** or choose **Tools > Calibration** from the menu bar.

Step 3 Select the **Single-Screen Mode** tab.

Step 4 Select a communication port and screen.

Step 5 Select the **Manage Coefficients** tab.

Figure 6-3 Calibration coefficient management

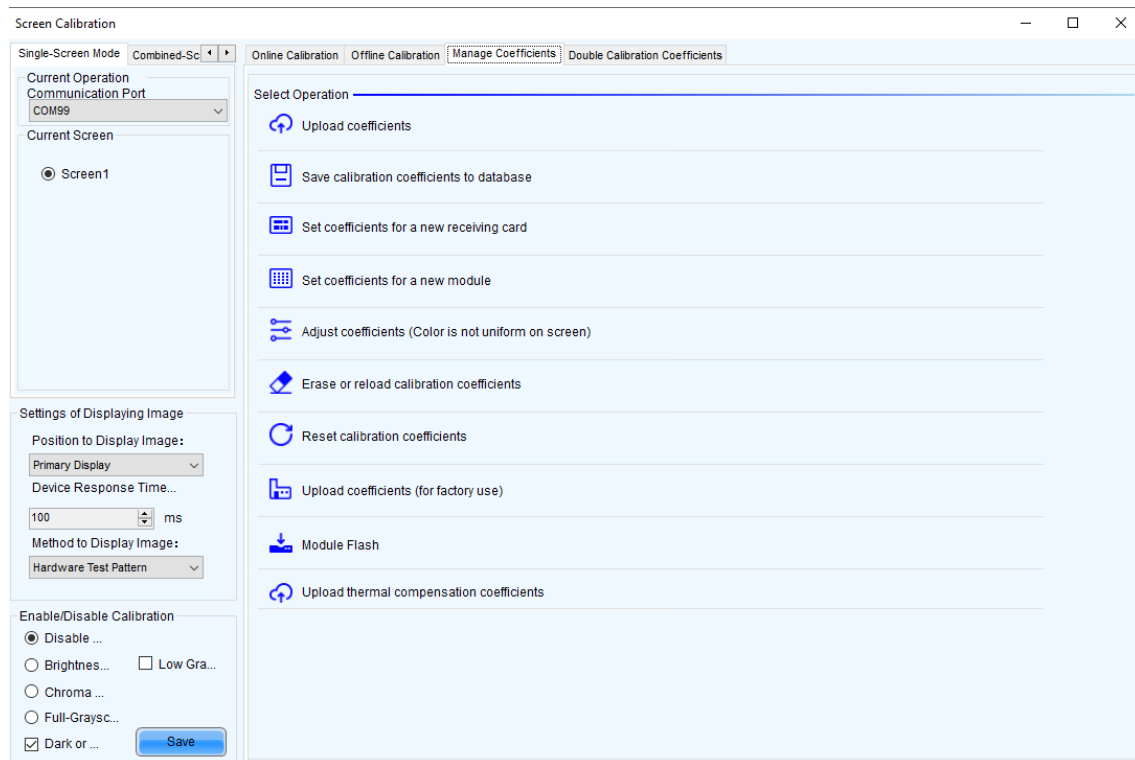

Step 6 Perform the following operations as required. During the operation, you can select **Disable Calibration**, **Brightness Calibration**, **Chroma Calibration**, or **Full-grayscale Calibration** on the left. **Dark or Bright Line Correction** and **Low-grayscale Calibration** can also be selected at the same time. After saving, you can view the effect of applied coefficients on the screen.

+ Upload coefficients

- Pixel level calibration database: Select the cabinet or screen calibration database file from the local computer and fast or stably upload the calibration coefficients to receiving cards.
- Dark or bright line database: Select the dark or bright line correction database file from the local computer and stably upload the calibration coefficients to receiving cards.
- Full-Grayscale Calibration Database: Select the full-grayscale calibration database file from the local computer and stably upload the calibration coefficients to receiving cards.

Stable uploading takes more time than fast uploading, but it is more stable and reliable.

+ Save calibration coefficients to database

Save the calibration coefficients in the receiving cards to an existing or new database. The coefficients for full-grayscale calibration will also be saved if **Full-Grayscale** is selected.

✦ **Set coefficients for a new receiving card**

Get calibration coefficients by uploading calibration database file or referring to one or more surrounding cabinets. Adjust and save the coefficients to receiving cards as required.

✦ **Set coefficients for a new module**

Get calibration coefficients by uploading calibration database file or referring to one or more surrounding modules. Adjust and save the coefficients to receiving cards as required.

✦ **Adjust coefficients (Color is not uniform on screen)**

Adjust the current calibration coefficients of receiving cards or adjust the coefficients by referring to the surrounding area. After the adjustment, you can also apply the coefficients to other specified areas.

✦ **Erase or reload calibration coefficients**

Erase the calibration coefficients in the application areas of receiving cards or reload calibration coefficients from application areas. You are advised to back up the database file before erasing it.

✦ **Reset calibration coefficients**

Set calibration coefficients to specified values.

✦ **Upload coefficients (for factory use)**

Upload the calibration coefficients in the cabinet calibration database file to the corresponding cabinets in turn according to the imported or read cabinet ID and export a screen calibration database file. Stable uploading takes more time than fast uploading, but it is more stable and reliable.

✦ **Module Flash**

Check module flash memory status, view the calibration coefficients of modules and receiving cards, and save calibration coefficients to the receiving cards and modules based on their addresses or the topology.

Type "admin" with your keyboard. The **Save Calibration Coefficients to Module** button is displayed.

- **Coef Type:** The calibration coefficient type, including normal coef, low-grayscale coef, and full-grayscale coef.
- **SPI Bit Rate Level:** The speed level of reading and uploading the calibration coefficients, 4 levels included
- **Auto Upload Module Calibration Coefficients:** When this function is selected, if the system detects that a cabinet ID is changed after the control system is powered on, the calibration coefficients in the module flash memory will be automatically uploaded to the receiving card.

✦ **Upload thermal compensation coefficients**

Import the thermal compensation coefficient file or read the coefficients from the hardware to adjust the red, green and blue coefficients individually, and send and save the coefficients.

- **Adjust:** Set the stepping of adjusting the coefficients.
- **Enable Temperature Calibration Coefs:** Apply the coefficients and check the effect on the screen.
- **Clear:** Clear the pixel level brightness and chroma calibration coefficients.
- **Export:** Export the thermal coefficient file.
- **Erase:** Erase the thermal coefficients.

Notes

Types and causes of module flash memory check errors:

- **Hardware Fault:** Screen configuration or flash topology is not consistent with the actual condition.
- **Communication Error:** There is a problem with hardware connection.
- **Flash Topology Error:** The module does not have flash memory or no flash topology is configured in **Screen Configuration**.

The **Coef Type** parameter value include normal coefficient, low-grayscale coefficient and full-grayscale coefficient. To set that parameter value to low-grayscale coefficient or full-grayscale coefficient, ensure that both the driver chip and receiving card support low-grayscale coefficient or full-grayscale coefficient.

Related Operations

During coefficient management, three methods are provided for you to select an area for coefficient management.

Figure 6-4 Selecting an area for coefficient management

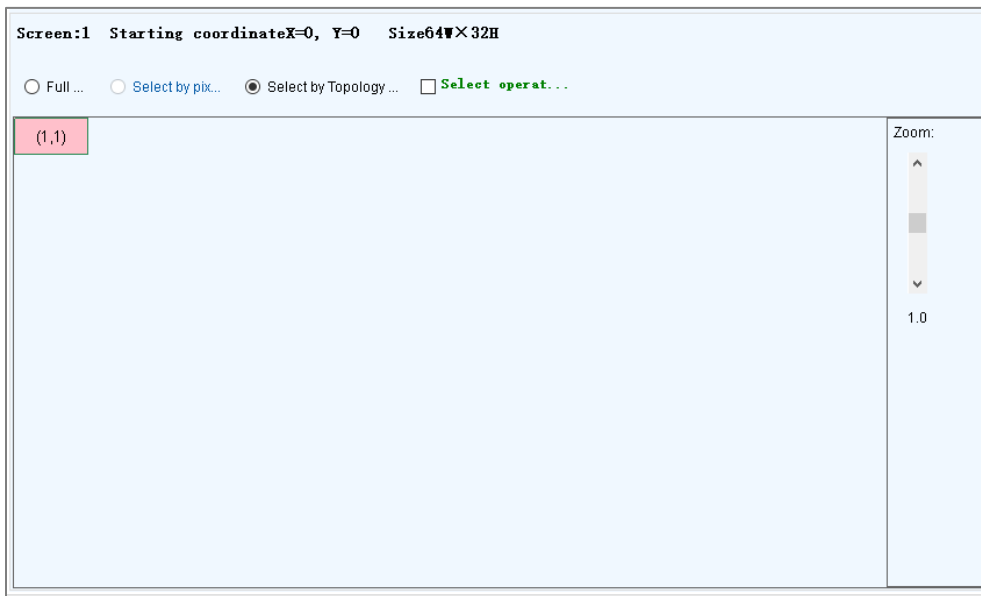

- Full screen: Manage the coefficients of the entire screen.
- Select by pixel area: Manage the coefficients of a specified area.
For full-grayscale calibration database file, the parameter **Upload by area** is displayed at the bottom of the page. If you want to upload the data of full-grayscale database split by the split tool to a certain location, please select **Upload by area** and set other parameters.
- Select by Topology or List: Manage the coefficients of a specified cabinet, module or pixels. For a standard screen, a cabinet topology is displayed. For a complex screen, a cabinet list is displayed. If it is not convenient to select an area with the software, you can select **Select Area on Screen** to select the area on the display window.

Two methods are provided for calibration coefficient adjustment. You can display or hide the color window during the adjustment.

+ Simple Adjustment

As shown in Figure 6-5, drag the slider to adjust the values of red, green and blue. Click **Advanced Adjustment** to open advanced adjustment page.

+ Advanced Adjustment

As shown in Figure 6-6, drag the slider to adjust the brightness, saturation and hue for red, green and blue, and adjust color temperature. Click **Simple Adjustment** to go back to simple adjustment page.

Figure 6-5 Simple adjustment

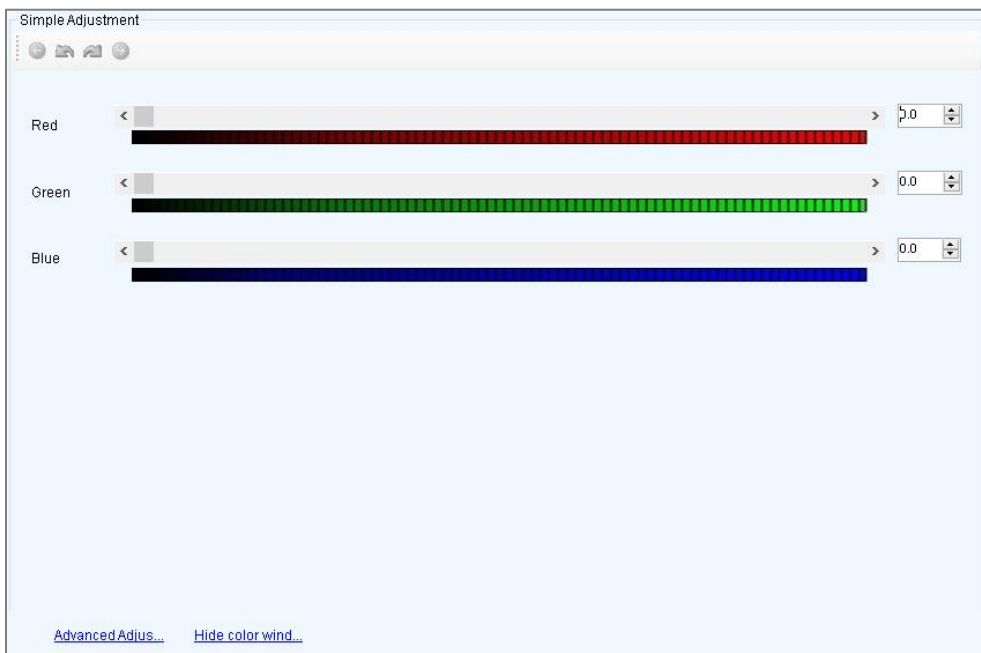

Figure 6-6 Advanced adjustment



6.1.4 Manage Double Calibration Coefficients

Applications

View calibration coefficients saved in the application area and factory area, get calibration coefficients in the factory area, and save calibration coefficients to the factory area.

Applicable Products

The A5, A5s, A7, A7s, A8, A8s, A9s and A10s Plus receiving cards

Prerequisites

None

Related Information

Calibration coefficients can be saved in both the factory area and application area of a receiving card. A copy of coefficients is saved in the factory area before a cabinet leaves the factory. The calibration coefficients usually used by users are in the application area. If necessary, calibration coefficients in the factory area can be restored to the application area.

Operating Procedure

- Step 1 On the menu bar, choose **User > Advanced Synchronous System User Login**. Enter the password and click **OK**.
The default password is "admin".



- Step 2 Click **Calibration** or choose **Tools > Calibration** from the menu bar.
- Step 3 Select the **Single-Screen Mode** tab or **Combined-Screen Mode** tab.
- Step 4 In single-screen mode, select a communication port and a screen. In combined-screen mode, skip this step.
- Step 5 Select the **Double Calibration Coefficients** tab.

Figure 6-7 Managing double calibration coefficients

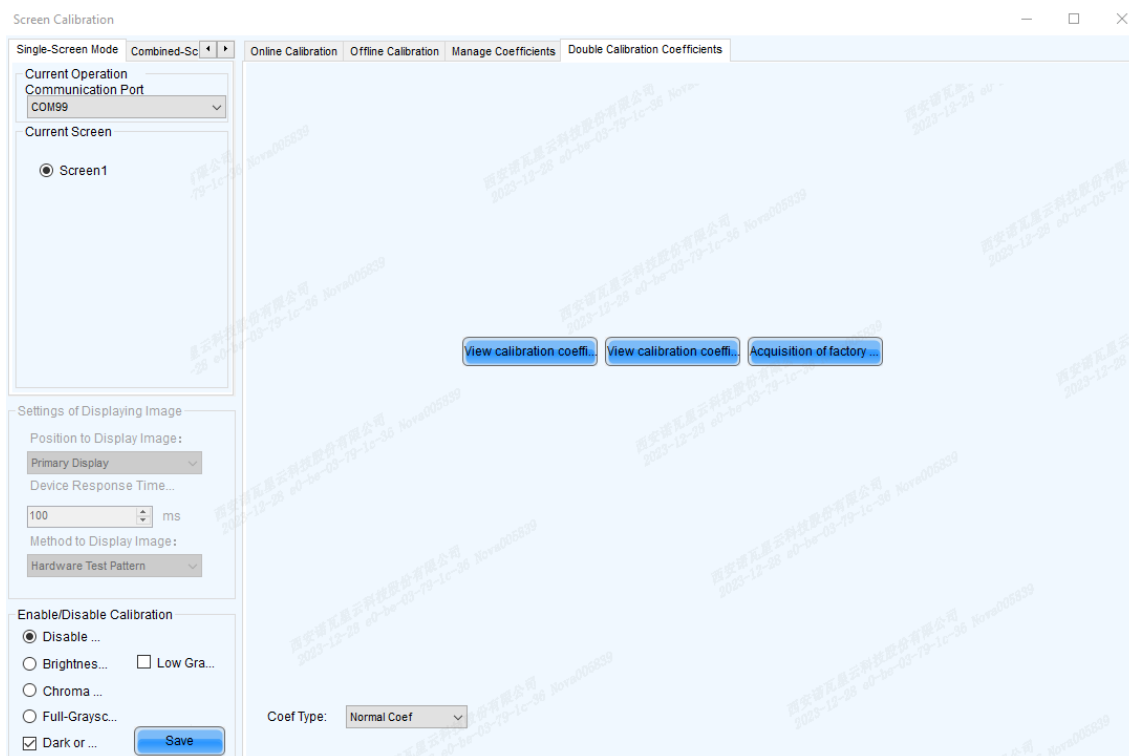

Step 6 Perform the following operations as required.

✦ **View calibration coefficients in application area**

Click **View calibration coefficients in application area**, select **Disable Calibration**, **Brightness Calibration** or **Chroma Calibration**, and view the application result of calibration coefficients on the screen.

✦ **View calibration coefficients in factory area**

Click **View calibration coefficients in factory area**, select **Disable Calibration**, **Brightness Calibration** or **Chroma Calibration**, and view the application result of calibration coefficients on the screen.

✦ **Get calibration coefficients in factory area**

Click **Acquisition of factory area correction factor** to restore the calibration coefficients from factory area to application area.

✦ **Save calibration coefficients to factory area**

Type "admin" with your keyboard. A **Save coefficients to factory area** button is displayed. Click the button to save the calibration coefficients in the application area to factory area.

6.2 Adjust Brightness

6.2.1 Adjust Brightness Manually

Applications

Manually adjust the screen brightness, Gamma, color temperature and color space to change the brightness and chroma expressiveness of the screen in real time, meeting the environment condition and user needs.

Applicable Products

- Individual Gamma adjustment for RGB:
 - If the bit depth of input source for the sending card is 8bit, the applicable receiving cards include the A4, A4s, A5, A5s, A5s Plus, A7, A7s, A7s Plus, A8, A8s, A9s, A10s Plus, DH7512 and DH3208.
 - If the bit depth of input source for the sending card is 10bit or 12bit, the applicable sending cards include the MCTRL1600, MCTRL4K, MCTRL660 PRO, KT8, KT8E, KT16E, KT16C, MCTRL R5, MEE200 and MEE400.
- Gamma interlink: Applicable to receiving cards with TBS6332 or TBS6336 chips.

- Other functions: Applicable to all receiving cards and sending cards

Prerequisites

None

Related Information

Manual brightness adjustment is to set screen brightness manually. After NovaLCT is opened, you can directly perform the steps in Operating Procedure. After logging in to NovaLCT, you can also perform the operations in Custom Gamma, Custom Color Temperature and Custom Color Space of this section.

If the ambient brightness is high, adjust the screen brightness to a higher level to ensure clear display. If the ambient brightness is low, adjust the screen brightness to a lower level to reduce light pollution.

Operating Procedure

- Step 1 Click  or choose **Settings > Brightness** from the menu bar.
- Step 2 Select **Manual Adjustment**.
- Step 3 Drag the slider to adjust brightness and select **Grayscale** or **Contrast**. You can also set **Gamma Interlink** if the screen is using receiving cards with TBS6332 or TBS6336 chips.

Figure 6-8 Manual brightness adjustment



- Step 4 Do the following as required:

- ✦ **Adjust Gamma**

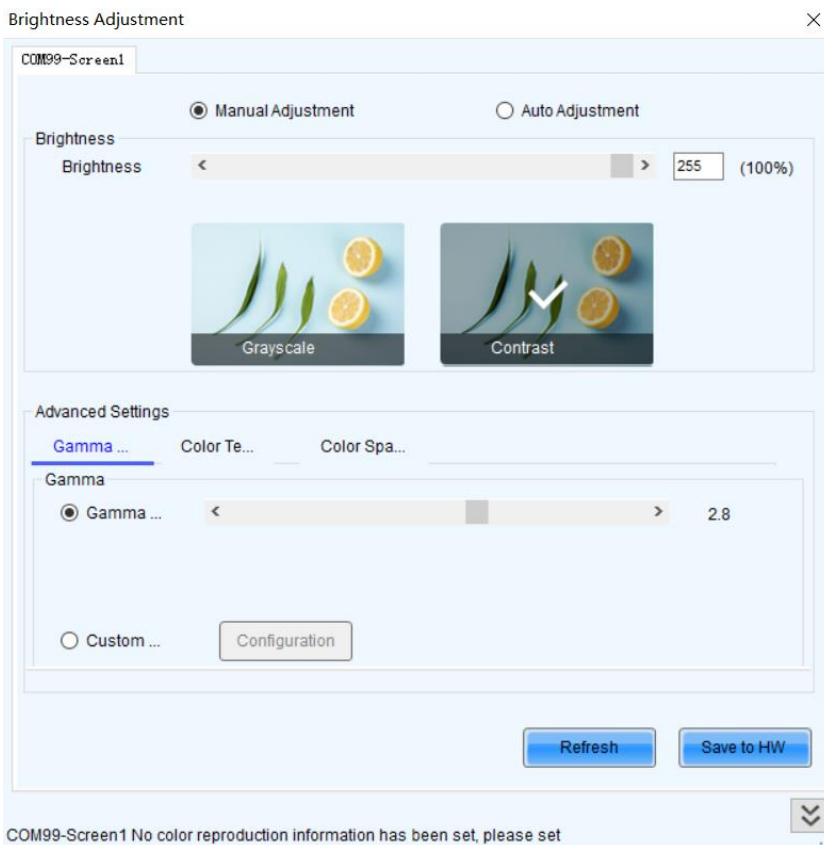
Drag the slider to adjust Gamma value.

- ✦ **Adjust color temperature**

Choose **Rough Adjustment** and drag the slider to adjust the color temperature. Or choose **Precise**

Adjustment and click a custom color temperature to use it, such as

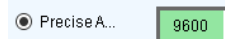

- ✦ **Adjust color space**

Disable color space, enable a standard color space (PAL/NTSC), or enable a custom color space, such as

Notes

After logging in to NovalCT, you can set custom Gamma, custom color temperature and custom color space. For details, see Custom Gamma, Custom Color Temperature and Custom Color Space.

Step 5 After the configuration is done, click **Save to HW** to save the configuration to the hardware.

Custom Gamma

Step 1 On the **Gamma Adjustment** page, select **Custom Gamma Adjustment**.

Step 2 Click **Configuration** to open the dialog box shown in Figure 6-9. When using receiving cards with TBS6332 or TBS6336 chips and **Gamma Interlink** is selected, click **Configuration** to open the dialog box shown in Figure 6-9.

Figure 6-9 Custom Gamma adjustment 1

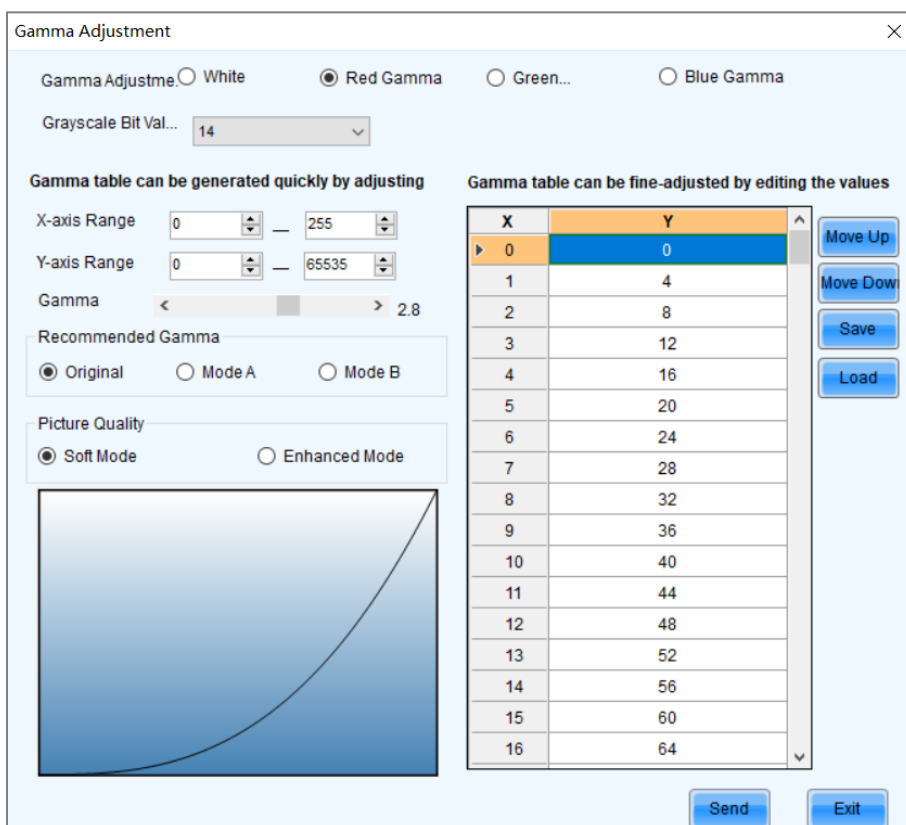
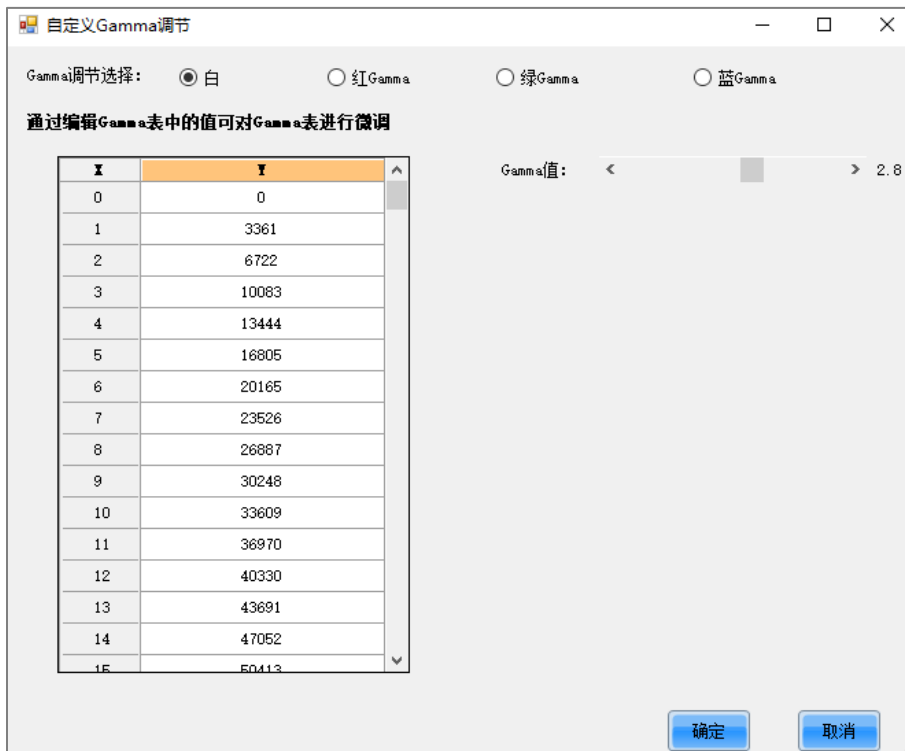

Figure 6-10 Custom Gamma adjustment 2



Step 3 If the control system supports individual Gamma adjustment for RGB, select **White** to adjust the Gamma curves for red, green and blue at the same time. Or, select **Red Gamma**, **Green Gamma**, or **Blue Gamma** to adjust the Gamma curve for a single color. If the control system does not support individual Gamma adjustment for RGB, skip this step.

Step 4 Perform any of the following operations as required to configure the Gamma curve.

- ✦ **Load a Gamma configuration file**
Click **Load** to load a Gamma configuration file.
- ✦ **Adjust the Gamma values manually**
Drag the slider to adjust the Gamma values.
- ✦ **Adjust the Gamma table manually**
Double click a value in the Y column to edit the value, and select a value in the Y column and click **Move Up** or **Move Down**.

Step 5 Set relevant parameters.

- Grayscale Bit Value: Use the default value.
- X-axis Range: It indicates the range of X-axis for Gamma curve. The X-axis ranges for 8-bit, 10-bit and 12-bit input sources are 0–255, 0–1023 and 0–4095 respectively.
- Y-axis Range: It indicates the range of Y-axis for Gamma curve. The range is always 0–65535.
- Recommended Gamma: The original mode is contrast preferred and Mode A is grayscale preferred. Mode B falls between those two modes.
- Picture Quality: When the Gamma curve is in Mode A or B, the picture quality can be set to soft mode or enhanced mode.

Step 6 After the settings are done, click **Send** to send the configuration to the hardware.

Step 7 (Optional) Click **Save** to save the Gamma information as a configuration file.

Custom Color Temperature

Step 1 On the **Color Temperature Adjustment** page, select **Precise Adjustment**.

Step 2 Click  to open the dialog box shown in [Figure 6-11](#).

Figure 6-11 Custom color temperature



- Step 3 If you have a color temperature configuration file (.fcg), click **Import** to complete the configuration quickly. If you do not have a color temperature configuration file, continue performing the following operations to manually complete the configuration.
- Step 4 Click **Add** to open the dialog box shown in [Figure 6-12](#).

Figure 6-12 Adding color temperature information

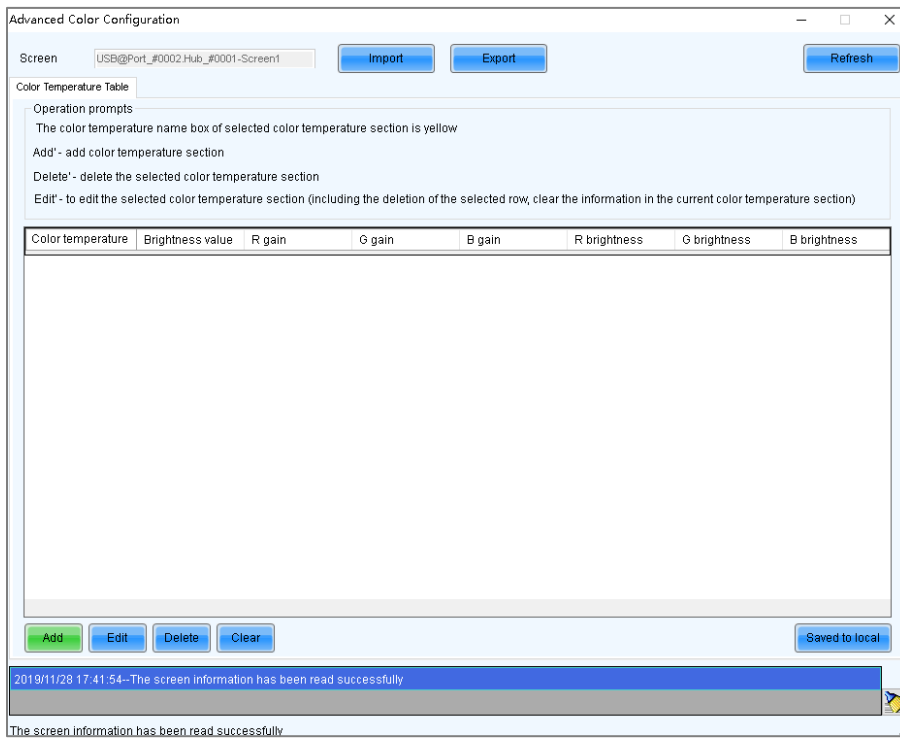
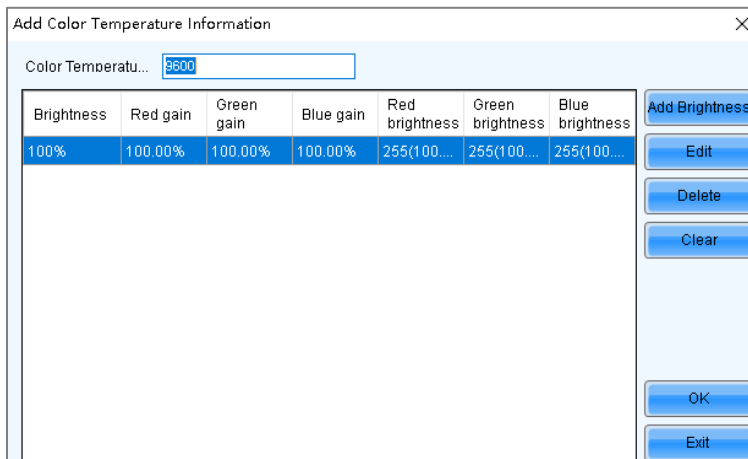

- Step 5 Click **Add Brightness** to open the dialog box shown in [Figure 6-13](#).

Figure 6-13 Adding brightness information

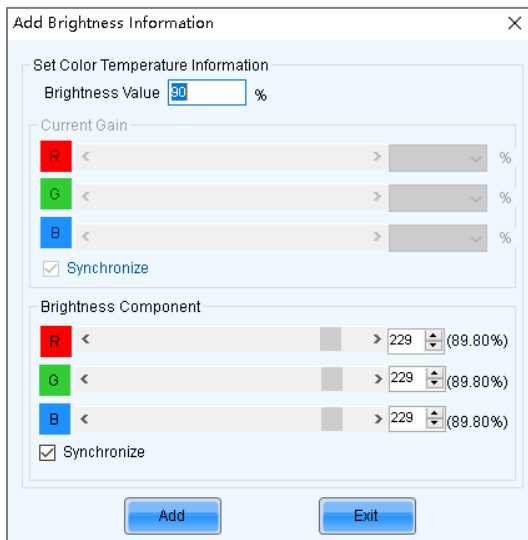

Step 6 Add color temperature information corresponding to the specified brightness values.

Current Gain is a color temperature parameter of modules. This parameter can be set when supported by module chips. **Brightness Component** is a color temperature parameter of receiving cards. If **Synchronize** is selected, the R, G and B parameters will be set to the same value. You can edit, delete and clear the color temperature information if necessary.

Step 7 After the configuration is done, click **Save to local** to save the custom color temperature. A corresponding button will be displayed next to **Precise Adjustment**.

Step 8 (Optional) Click **Export** to save the current color temperature information as a configuration file.

Custom Color Space

Step 1 On the **Color Space Adjustment** page, click  to open the dialog box shown in [Figure 6-14](#).

Figure 6-14 Custom color space

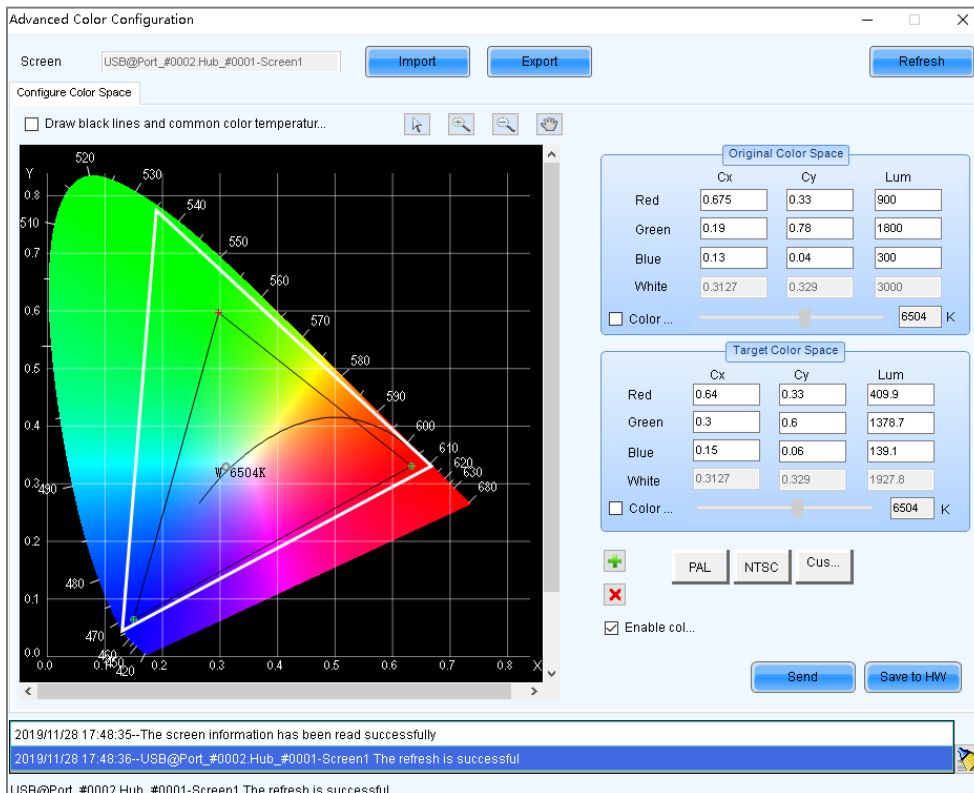

Step 2 Set the original color space.

The white triangle represents the original color space. The target color space is configured based on the original color space. You are advised to use a colorimeter to measure the original color space of the screen and then enter the measured values in the original color space table.

Step 3 Perform any of the following operations as required to set custom color space.

✦ **Select a standard color space**

Click **PAL** or **NTSC** to use one of the standard color spaces.

✦ **Select an existing custom color space**

If there is a custom color space, click to use it. If not, click **Import** to import a custom color space, or click  to create a custom color space and then click to use it.

✦ **Adjust the color space diagram manually**

Drag vertexes of the black triangle in the diagram on the left to adjust the target color space. If **Draw black lines and common color temperature points** is selected, a black curve (color temperature curve) and some common color temperature points (solid round spots) will be displayed in the diagram.

✦ **Adjust the color space values manually**

Change the parameter values in the target color space table for precise adjustment.

Step 4 After the configuration is done, select **Enable color space adjustment** to apply the target color space, and click **Send** to send the configuration information to the hardware.

Step 5 Click **Save to HW** to save the information to the hardware.

6.2.2 Adjust Brightness Automatically

Applications

Set rules for automatic brightness adjustment, allowing NovaLCT or sending cards to automatically adjust screen brightness.

Applicable Products

All sending cards

Prerequisites

When screen brightness is adjusted based on ambient brightness, a light sensor must be connected to the sending card or multifunction card.

If the light sensor is connected to the multifunction card, peripheral configuration needs to be completed on multifunction card management page.

Related Information

After you configure the automatic brightness adjustment, two adjustment modes are provided.

✦ **Software adjustment mode**

NovaLCT automatically adjusts screen brightness. This mode takes effect when the control PC is connected to the sending card and monitoring is running. Combined-screen brightness, color temperature and Gamma must be adjusted and night mode must be enabled with the software.

The adjustment process will be recorded as a log which can be exported and viewed in iCare of VNNOX cloud platform.

✦ **Hardware adjustment mode**

The sending card automatically adjusts screen brightness. This mode takes effect when the control PC and sending card are disconnected or monitoring stops running.

Combined screens do not support this mode.

The adjustment process will not be recorded as a log.

Operating Procedure

Step 1 Click  or choose **Settings > Brightness** from the menu bar.

Step 2 Select **Auto Adjustment**.

Step 3 Click **Wizard Settings**.

If the auto adjustment table is configured, you can add, delete and modify items in the table, or click **Light Sensor Configuration** to set light sensor information.

Step 4 Select an adjustment mode as required and click **Next**.

Advanced adjustment

Screen brightness is adjusted by time periods. You can choose to adjust screen brightness according to specified brightness or ambient brightness.

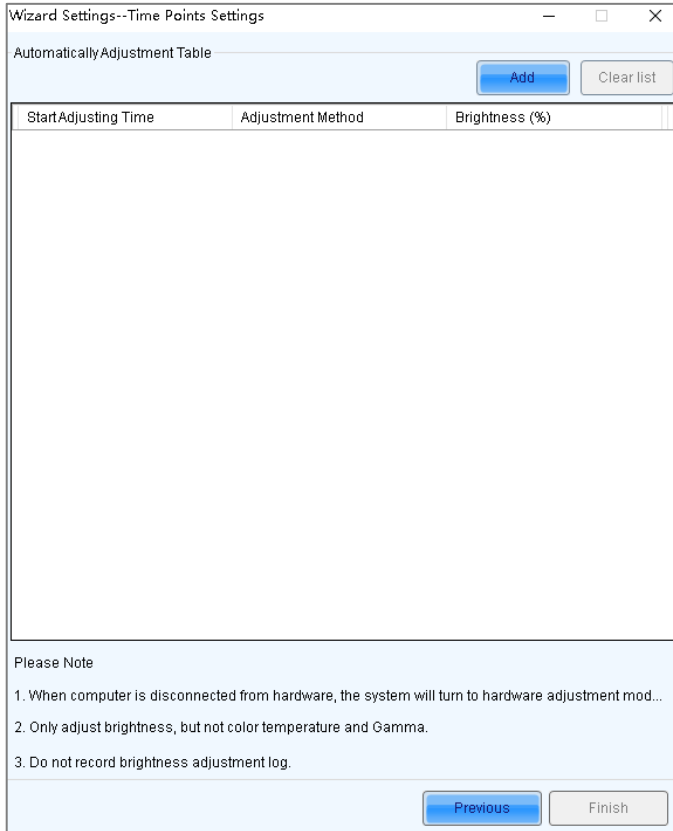

- a. Click **Add**.
- a. Set the start time and adjustment method and then click **OK**.

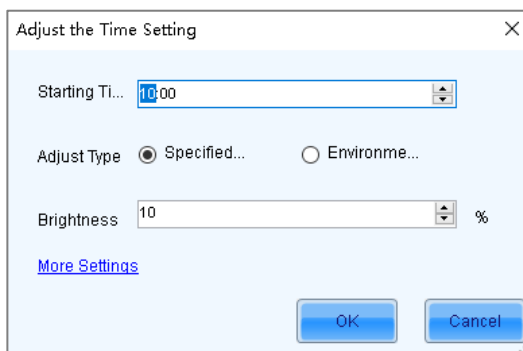

- b. Click **More Settings** to set color temperature and Gamma vale.
- The options in the drop-down box next to color temperature are the custom color temperatures.
- c. After the settings are done, click **Cancel** to close the dialog box.

As shown in the figure below, the two configuration items denote that screen brightness will be adjusted to 80% from 8:00 to 18:00 and adjusted to the corresponding values in the brightness mapping table according to ambient brightness from 18:00 to 8:00 of the next day.

	Start Adjusting Time	Adjustment Method	Brightness (%)		
<input checked="" type="checkbox"/>	08:00	Specified Brightness	80	Edit	Delete
<input checked="" type="checkbox"/>	18:00	Environment Brightness	--	Edit	Delete

- d. If there is no **Environment Brightness** under **Adjustment Method**, click **Finish**. If there is **Environment Brightness** under **Adjustment Method**, click **Next** and complete light sensor settings according to the description in Light Sensor Adjustment below.

Light sensor adjustment

Screen brightness is adjusted according to ambient brightness. Set the corresponding relations between ambient brightness and screen brightness in the ambient brightness mapping table.

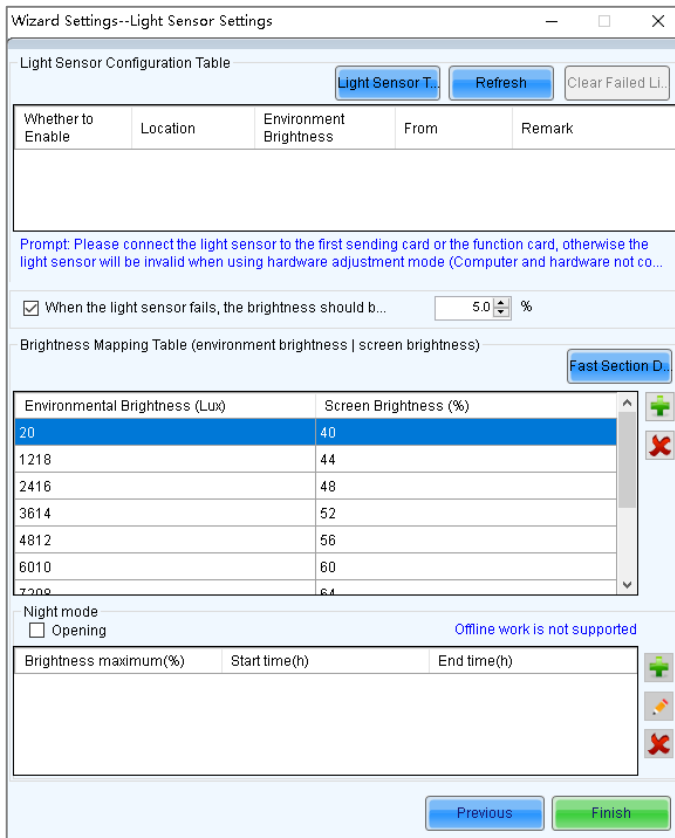

- a. Click **Light Sensor Test** to test the light sensors connected to the control system, including the light sensors connected to all sending cards and multifunction cards.
If you want to clear the ineffective light sensor information, click **Clear Failed Light Sensor Information**.
- b. (Optional) Select **When the light sensor fails, the brightness should be adjusted to** and set a brightness value.
If this option is not selected, the screen brightness will keep the last updated brightness value when the light sensor fails.
- c. Click or , or click **Fast Section Division** to set the brightness mapping table.
Fast section division can equally divide the ambient brightness range and screen brightness range into the specified number of segments.
- d. (Optional) Select **Opening** to enable night mode and set the maximum brightness of the specified time period.
When surrounding lights interfere with the light sensor or an exception occurs when the light sensor is collecting ambient brightness data, screen brightness may be too high. This can be avoided in night mode. If the start time and end time are the same, night mode takes effect all the time.
- e. Click **Finish**.

Step 5 After the settings are done, click **Save**.

Step 6 (Optional) Click **Export Log** to export the brightness adjustment log in software adjustment mode.

Step 7 (Optional) Set the advanced parameters of auto brightness adjustment.

- 1. On the taskbar, click and choose **Brightness Advanced Settings**.

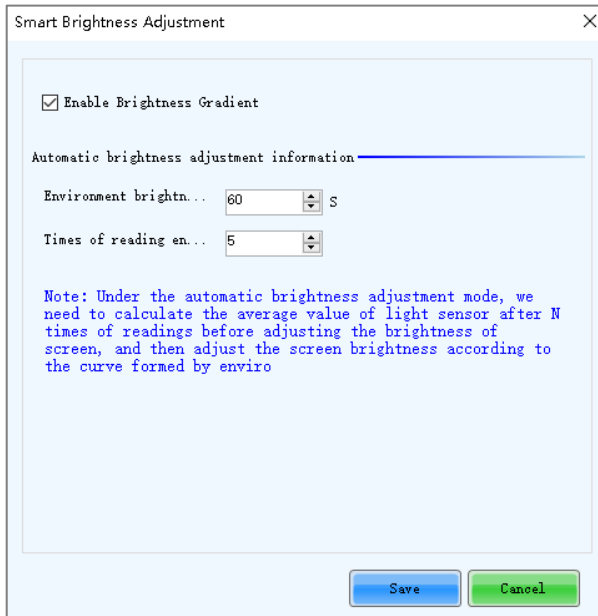

2. Select **Enable Brightness Gradient**. Screen brightness will gradually change to the target value.
3. Set the cycle and number of times for the light sensor to measure ambient brightness.

For example, if the cycle is 60 seconds and number of times is 5, the light sensor will measure ambient brightness every 60 seconds. After 5 times of measurement, NovaLCT will calculate the average of the measured values without the maximum and minimum ones. This average value is ambient brightness. If multiple light sensors are connected, NovaLCT will calculate the average of all the ambient brightness values.

4. Click **Save**.

6.3 Adjust Multi-batch Cabinets

Applications

Adjust the chroma of cabinets or modules from multiple batches to make the overall screen chroma more uniform.

Applicable Products

All receiving cards

Prerequisites

None

Related Information

None

Operating Procedure

- Step 1 On the menu bar, choose **Tools > Multi-batch Adjustment**.
- Step 2 Select **Manual Adjustment**.

If you have a configuration file, select **Apply Adjustment File** to quickly complete chroma adjustment for cabinets from multiple batches.

Figure 6-15 Multi-batch adjustment

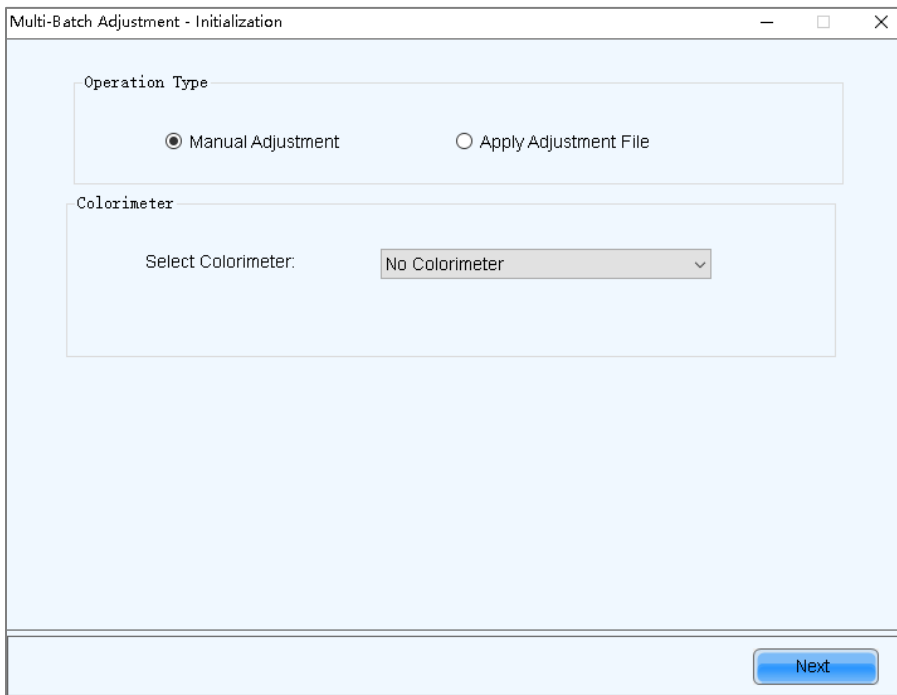

- Step 3 If no colorimeter is connected, select **No Colorimeter**. If a colorimeter is connected, select the colorimeter type and set its measurement accuracy.
- Step 4 Click **Next**.
- Step 5 Set the parameters of a sample batch.

Figure 6-16 Setting sample batch

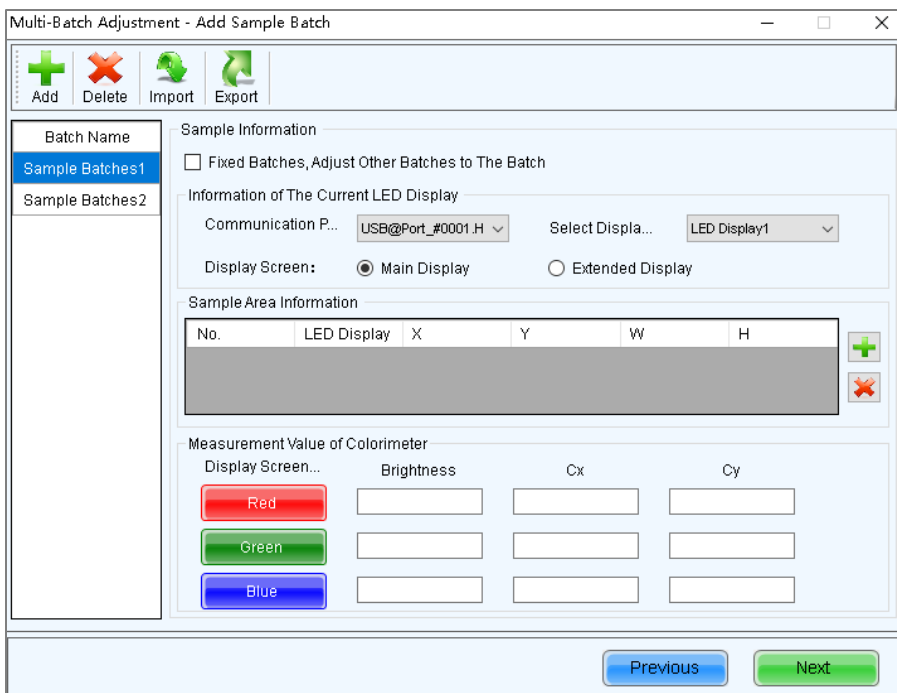

1. (Optional) Select **Fixed Batches, Adjust Other Batches to The Batch**.
Fixed sample batch is for reference and cannot be adjusted. All the sample batches can be adjusted without a fixed batch.
2. Select a communication port and screen.
3. Select a position to display image.
4. Click  to specify an operating area for the fixed sample batch.

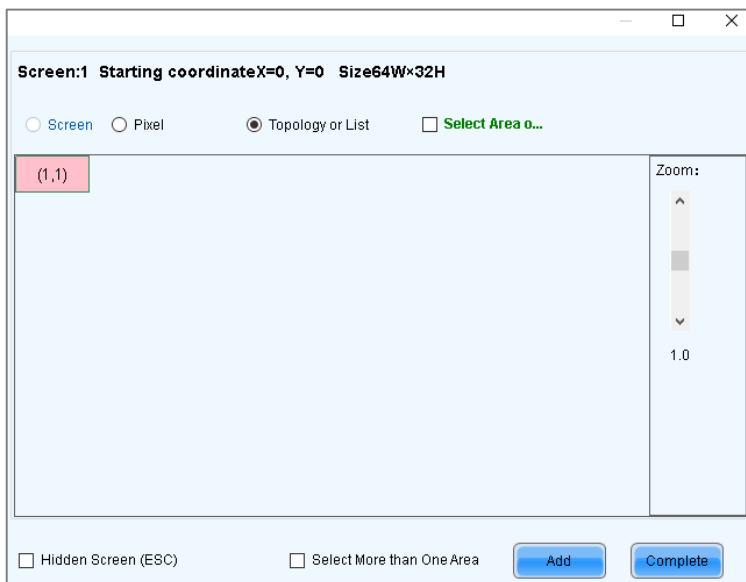

- Pixel: Perform operations in a specified area.
- Topology or List: Perform operations on a specified module or pixels. If it is not convenient to specify an area with the software, you can select **Select Area on Screen** to specify an area on the display window.

5. Click Red, Green and Blue in order to measure **Brightness**, **Cx** and **Cy** by using a colorimeter and enter the measured values. If no colorimeter is connected, skip this step.

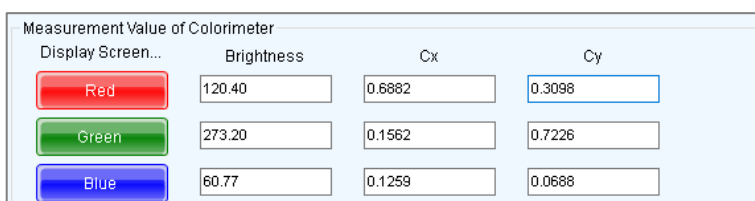

Step 6 Set other sample batches.

1. Import, add or delete other sample batches as required.
2. Select a sample batch and specify an operating area by following 4 in [Step 5](#).
3. Enter the values measured by the colorimeter by following 5 in [Step 5](#). If no colorimeter is connected, skip this step.

Step 7 Click **Next**.

Step 8 View the preliminary adjustment result, select a result option and click **Next**. If no colorimeter is connected, skip this step.

Figure 6-17 View the preliminary adjustment result

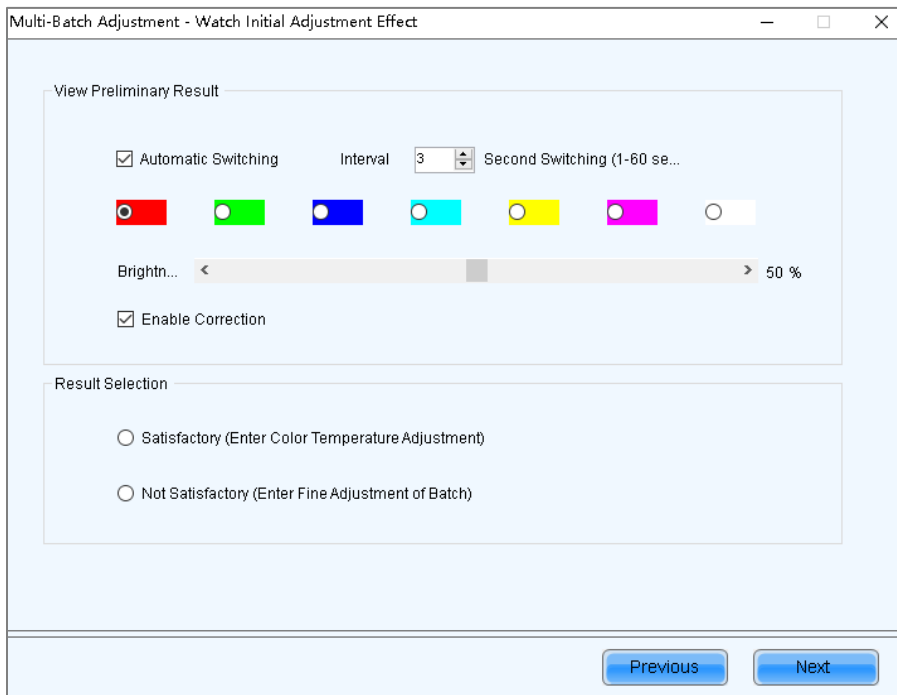

Selecting **Automatic Switching** automatically switches the display color. Selecting **Enable Correction** allows you to view the calibration result.

- If the calibration result is satisfactory, go to [Step 10](#).
- If the calibration result is not satisfactory, go to [Step 9](#).

Step 9 Fine tune the sample batch.

Figure 6-18 Fine tuning a sample batch

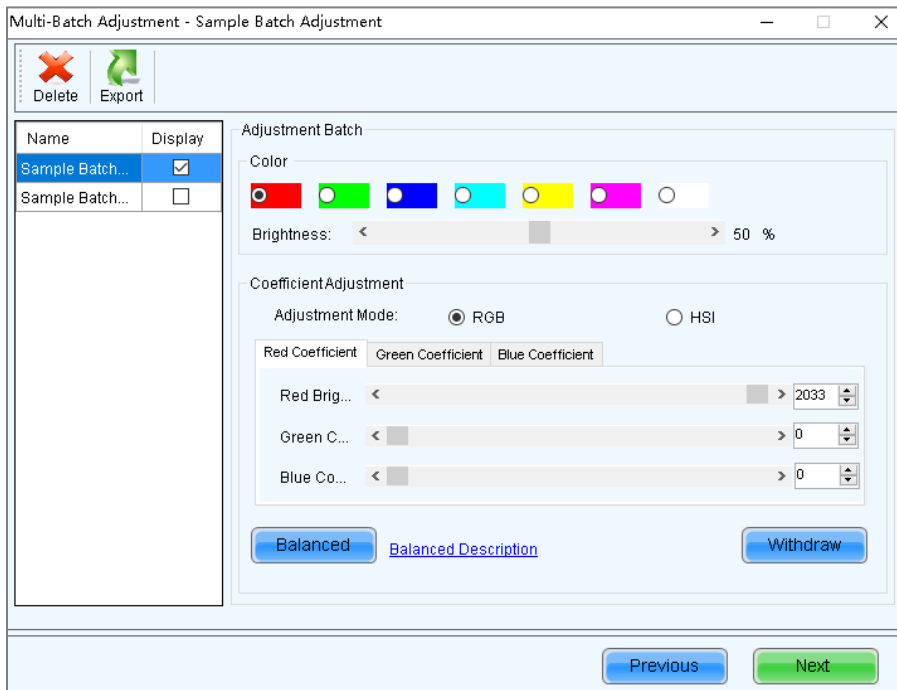

1. Select the sample batch to be displayed.
2. Select a display color.
3. Drag the slider to adjust brightness.
4. Select **RGB** or **HIS** and adjust the coefficients of red, green and blue.

You can click **Withdraw** to restore the coefficients.

- (Optional) Click **Balanced** and perform balanced adjustment for the sample batch in the dialog box that appears. Click **Balanced Description** to see the detailed description of balanced adjustment.

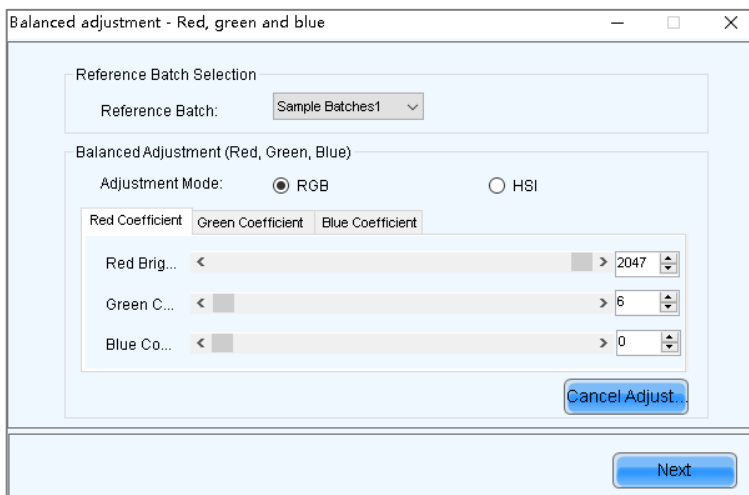

- Click **Next**.

Step 10 Select **Adjust Color Temperature**. Drag the slider to adjust color temperature and view the effect.

Figure 6-19 Adjusting color temperature

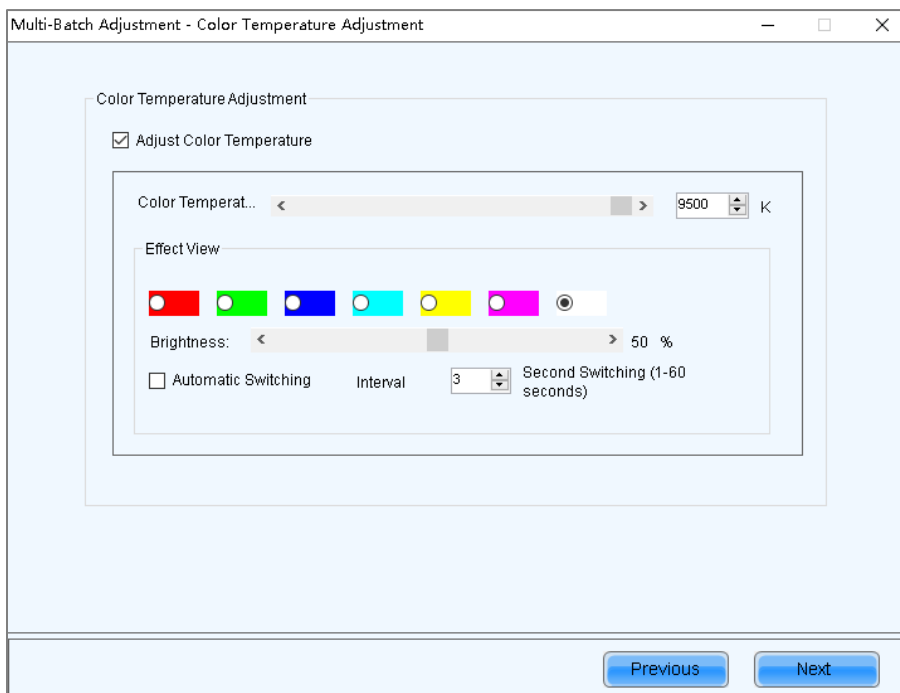

Step 11 After the adjustment is done, click **Next**.

Step 12 Click **Add Areas** to select the areas where the adjustment effect will be applied.

Figure 6-20 Applying adjustment effect

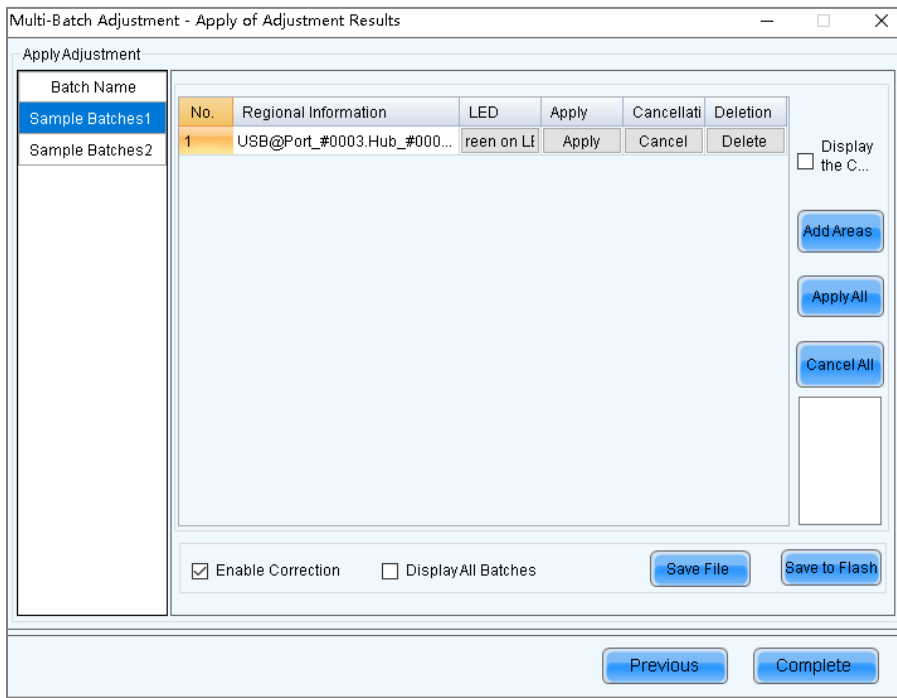

- Step 13 Click **Display screen on LED display** to view the adjustment effect.
- Enable Correction: After this option is selected, you can view the calibration result.
 - Display All Batches: After this option is selected, all sample batches are displayed.
- Step 14 Click **Apply** or **Apply All**.
- Step 15 Click **Save to Flash** to save the configuration to the hardware.
- Step 16 (Optional) Click **Save File** to save the configuration as a file (.lxy).
- Step 17 Click **Complete** and **OK**.

6.4 Adjust Dark or Bright Lines

Applications

Adjust dark or bright lines between cabinets or modules to improve visual experience.

Applicable Products

All receiving cards

Prerequisites

None

Related Information

None

Operating Procedure

- Step 1 On the menu bar, choose **Tools > Quickly Adjust Dark or Bright Lines > Adjust Dark or Bright Lines**.
- If you have a configuration file for dark or bright line adjustment, choose **Recover Dark or Bright Lines** to quickly complete dark or bright line adjustment.
- Step 2 Click the corresponding **Quickly Adjust** button according to the receiving card type and adjust dark or bright lines.

Figure 6-21 Adjusting dark or bright lines

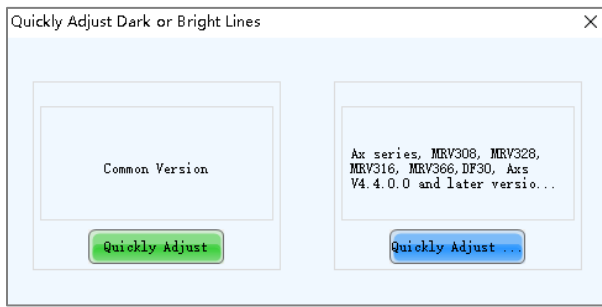

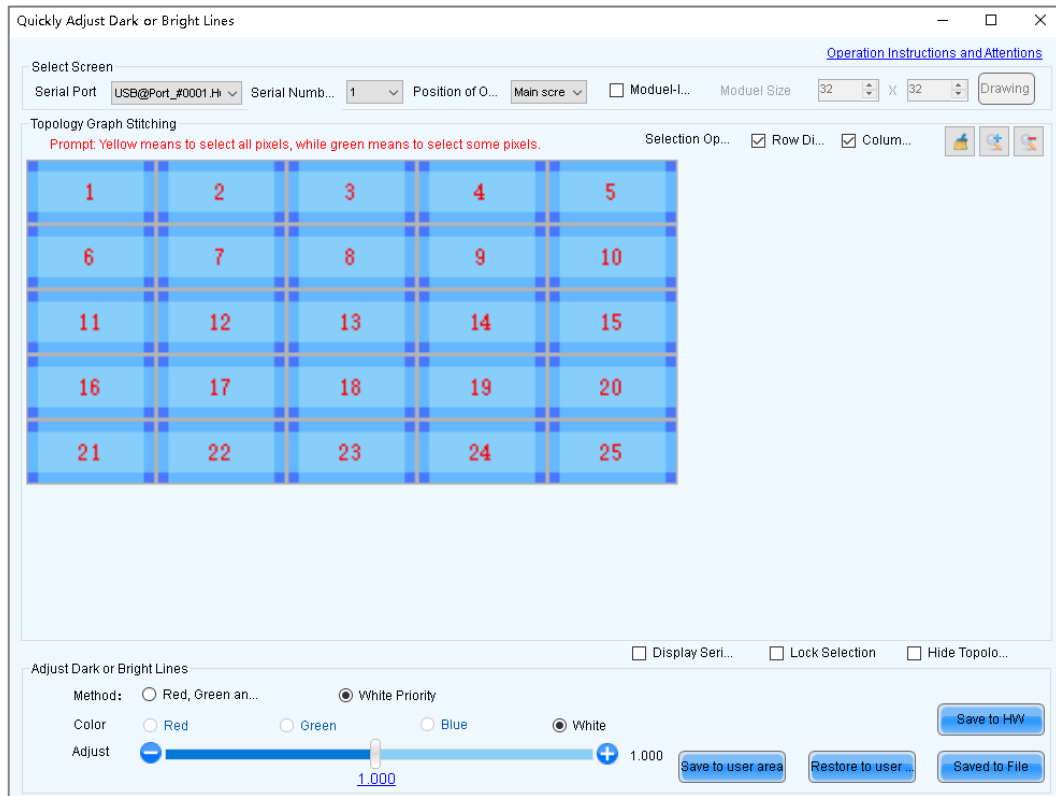

Common version



- a. Select a communication port and screen.
- b. Select a position to display image, including main screen and extended screen.
- c. To adjust dark or bright lines between modules, select **Module-level Adjustment**, set module size and then click **Drawing**. To adjust dark or bright lines between cabinets, skip this step.
- d. On the topology, select a target to adjust.
 Selection methods: Click borders and corners, click and drag the mouse to select borders and corners, or double click borders to select pixels.

 Deselection methods: Click selected borders and corners to deselect them or click  to deselect all the selected borders and corners.









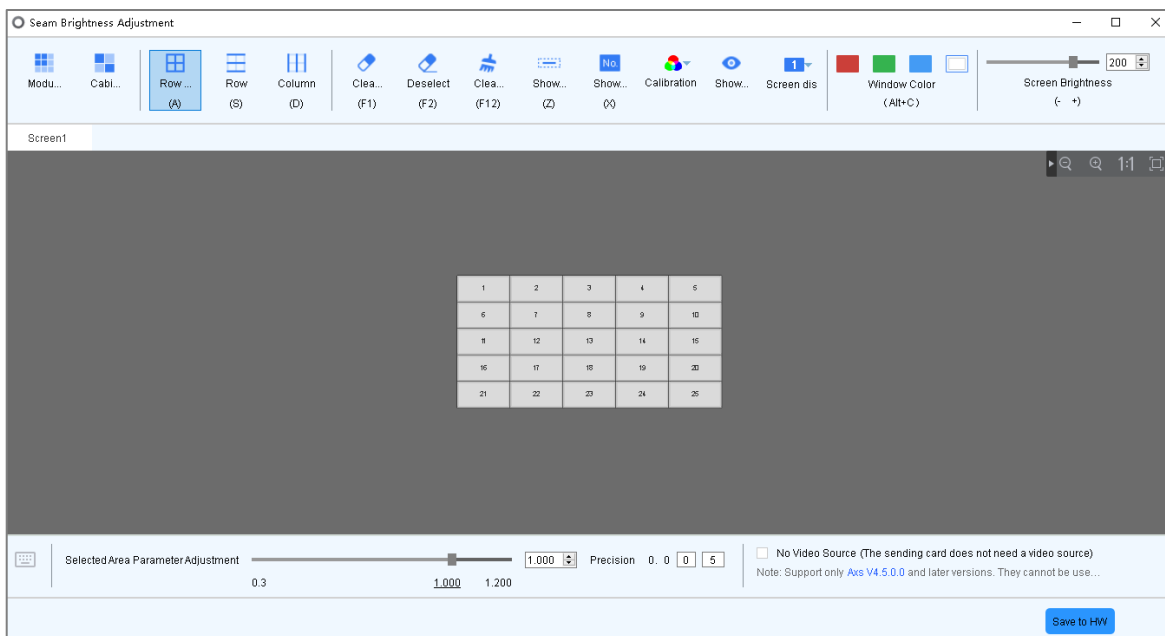





 Topology zooming: Click  or .
- e. (Optional) Select **Display Serial Number**, **Lock Selection** or **Hide Topology Graph** to display the cabinet or module numbers on the display window and lock or hide the topology.
- f. Select **Red**, **Green** and **Blue Priority** to adjust the coefficients of red, green and blue, or select **White Priority** to adjust the overall coefficient.
- g. After the settings are done, click **Save to HW** to save the configuration to receiving cards.
- h. (Optional) Click **Save to File** to save the configuration as a file.

Notes

- Clicking **Save to user area** saves the configuration to the application areas of receiving cards.
- Clicking **Restore to user area** restores the configuration of dark or bright lines according to the application areas of receiving cards.

Supported receiving cards: Ax series, MRV308, MRV328, MRV316, MRV366, DF30, Axs V4.4.0.0 and later



- Click  to select module mode or click  to select cabinet mode.
- Select a display color.
- Drag the slider to adjust screen brightness.
- Click  and choose to use the main screen or extended screen from the drop-down box for display.
 - : Disable calibration, select chroma calibration or brightness calibration.
 - : Show or hide the display window.
- Click or select the borders to be adjusted.
 - : Select all the borders.
 - : Select horizontal borders.
 - : Select vertical borders.
 - : Show or hide the flashing dotted borders on the display window.
 - : Show or hide module or cabinet numbers.
 - : Zoom out the topology.
 - : Zoom in the topology.
 - : Map the topology to the display window (1:1).
 - : Auto fit the topology to the canvas.
- Set the precision of adjustment and drag the slider to adjust the coefficient.
- After the settings are done, click **Save to HW** to save the configuration to the hardware.

6.5 Correct Brighter Pixels

Applications

Correct brightness of pixels that are brighter or darker than normal to fix the problem that the pixel brightness of the screen is not uniform after calibration.

Applicable Products

All receiving cards and sending cards

Prerequisites

Cabinets of the screen are calibrated or the entire screen is calibrated and the cabinet or screen calibration database file is saved.

Related Information

None

Operating Procedure

Step 1 On the menu bar, choose **Tools > More > Brighter Pixel Correction**.

Figure 6-22 Brighter pixel correction

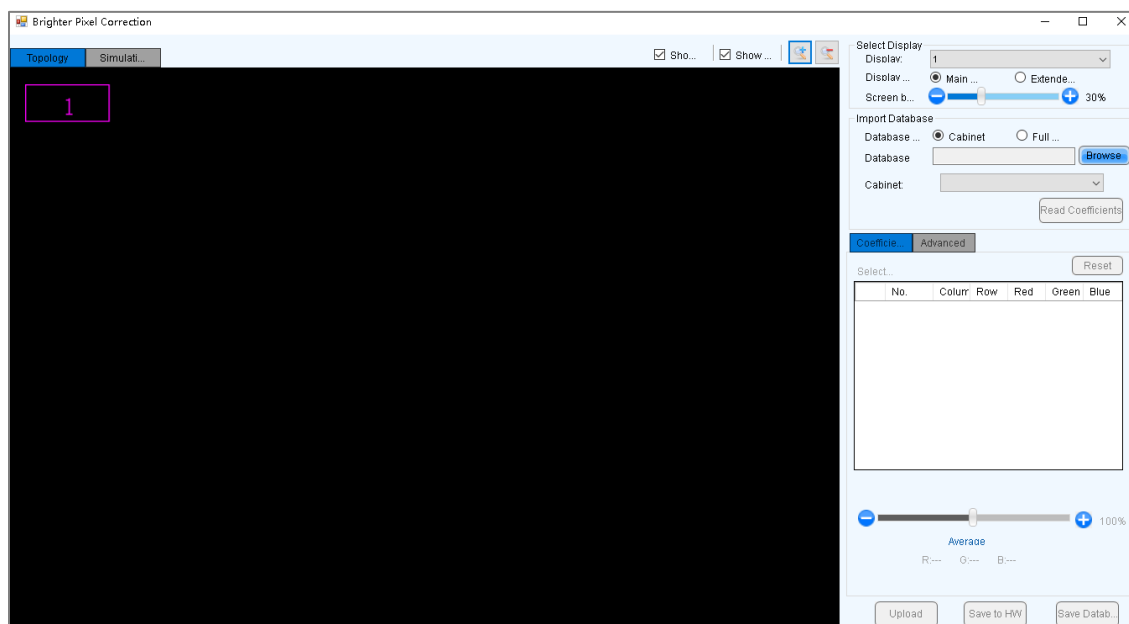

Step 2 Select a screen.

Step 3 Select a position to display image.

Step 4 Set the brightness of the display window.

Step 5 Select a database type, for example, **Cabinet**.

Step 6 Click **Browse** and select a database file. For example, select a cabinet calibration database file and click **Open**.

Step 7 On the **Topology** page, select an area and then select the **Simulation Diagram** tab.

Step 8 Click brighter pixels or select the area where there are brighter pixels and click .



- : Click to select a brighter pixel.
- : Select brighter pixels by clicking and dragging the mouse to form a selection box.
- : Select brighter pixels by clicking and dragging the mouse to form a selection oval.

Figure 6-23 Selecting brighter pixels



- Step 9 Select **Coefficient Adjustment** or **Advanced** to adjust coefficients.
- Step 10 After the settings are done, click **Upload** to save the configuration to the hardware.
- Step 11 Click **Save to HW** to save the configuration to the hardware.
- Step 12 (Optional) Click **Save Database** to save the configuration to the current database file.

6.6 Set Advanced Color

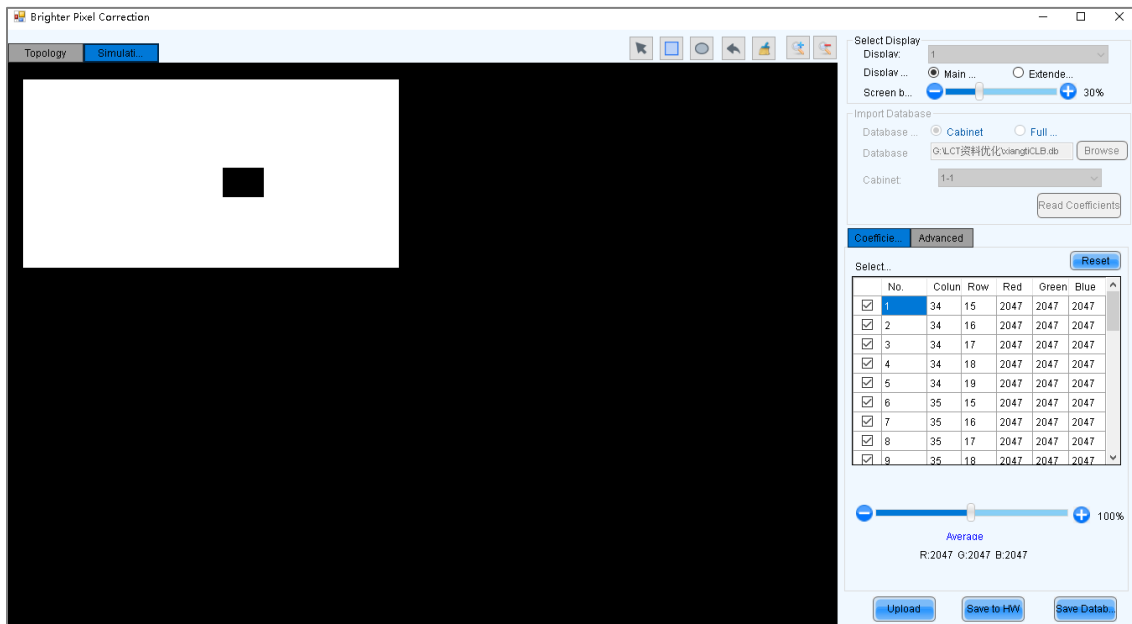
Applications

Improve the display effect of a screen by setting screen brightness, color space, color temperature, etc.

Applicable Products

- Color adjustment: Applicable to the NovaPro HD
- Other functions: Applicable to all sending cards

Prerequisites

None

Related Information

None

Operating Procedure

- Step 1 On the menu bar, choose **User > Advanced Synchronous System User Login**. Enter the password and click **OK**.
The default password is "admin".
- Step 2 Choose **Settings > Advanced Color Configuration**.
- Step 3 Click **Import** to quickly complete the configuration or continue performing the following operations to complete the configuration manually.
- Step 4 On the **Factory Setting** tab page, adjust parameters and then click **Save to HW**.

Figure 6-24 Factory settings

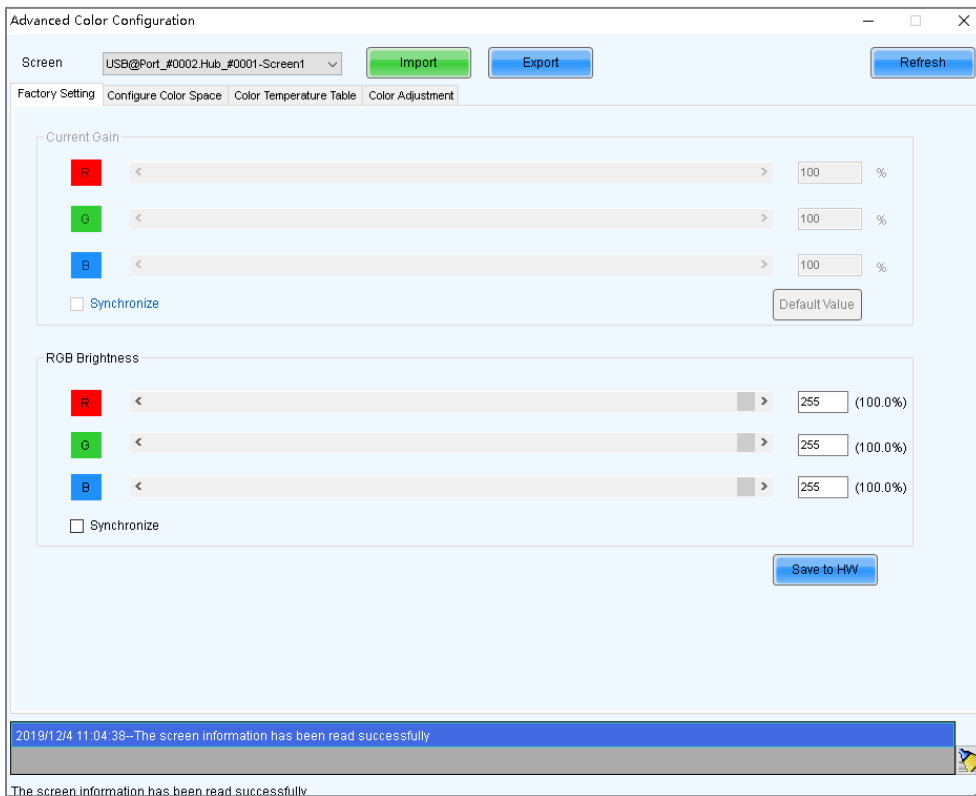

- Current Gain: This is a module parameter and can be set when supported by module chips. Clicking **Default Value** can reset the value.
- RGB Brightness: This is a receiving card parameter.

If **Synchronize** is selected, the R, G and B parameters will be set to the same value.

Step 5 Select **Configure Color Space** to set color space.

Figure 6-25 Configuring color space

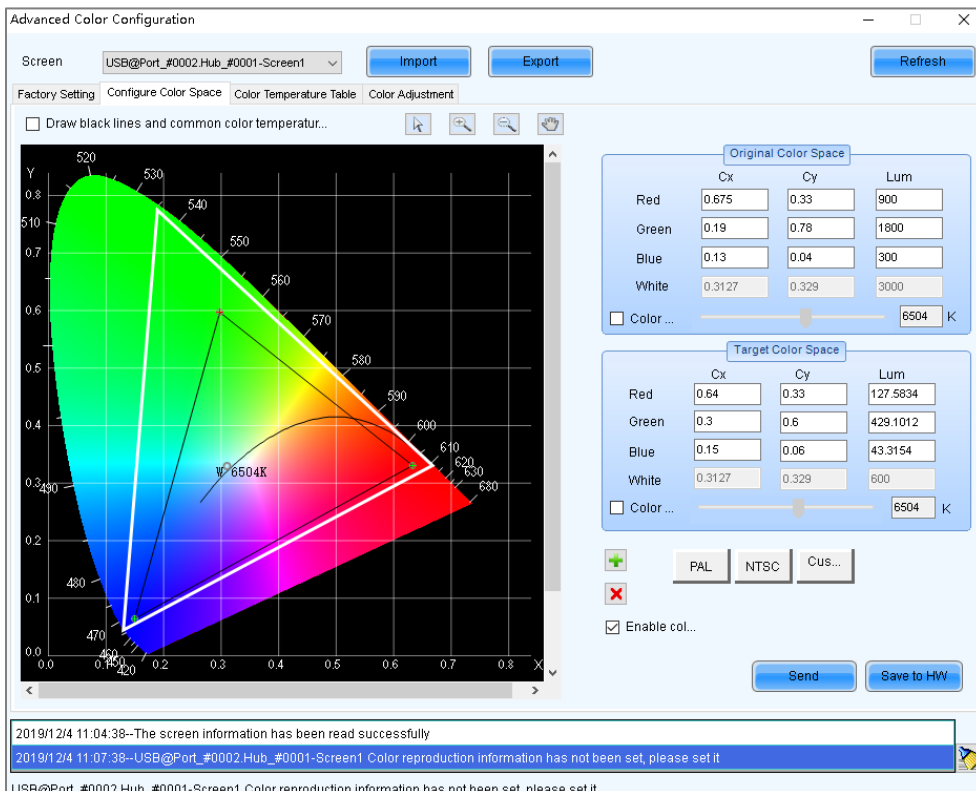

1. Set the original color space.

The white triangle represents the original color space. The target color space is configured based on the original color space. You are advised to use a colorimeter to measure the original color space of the screen and then enter the measured values in the original color space table.

2. Perform any of the following operations as required to set custom color space.

- Select a standard color space

Click **PAL** or **NTSC** to use one of the standard color spaces.

- Select an existing custom color space

If there is a custom color space, click to use it. If not, click **Import** to import a custom color space, or click  to create a custom color space and then click to use it.

- Adjust the color space diagram manually

Drag vertexes of the black triangle in the diagram on the left to adjust the target color space. If **Draw black lines and common color temperature point** is selected, a black curve (color temperature curve) and some common color temperature points (solid round spots) will be displayed in the diagram.

- Adjust the color space values manually

Change the parameter values in the target color space table for precise adjustment.

3. After the configuration is done, select **Enable color space adjustment** to apply the target color space, and click **Send** to send the configuration information to the hardware.

4. Click **Save to HW** to save the configuration to the hardware.

Step 6 Select **Color Temperature Table** to set color temperature.

Figure 6-26 Color temperature table

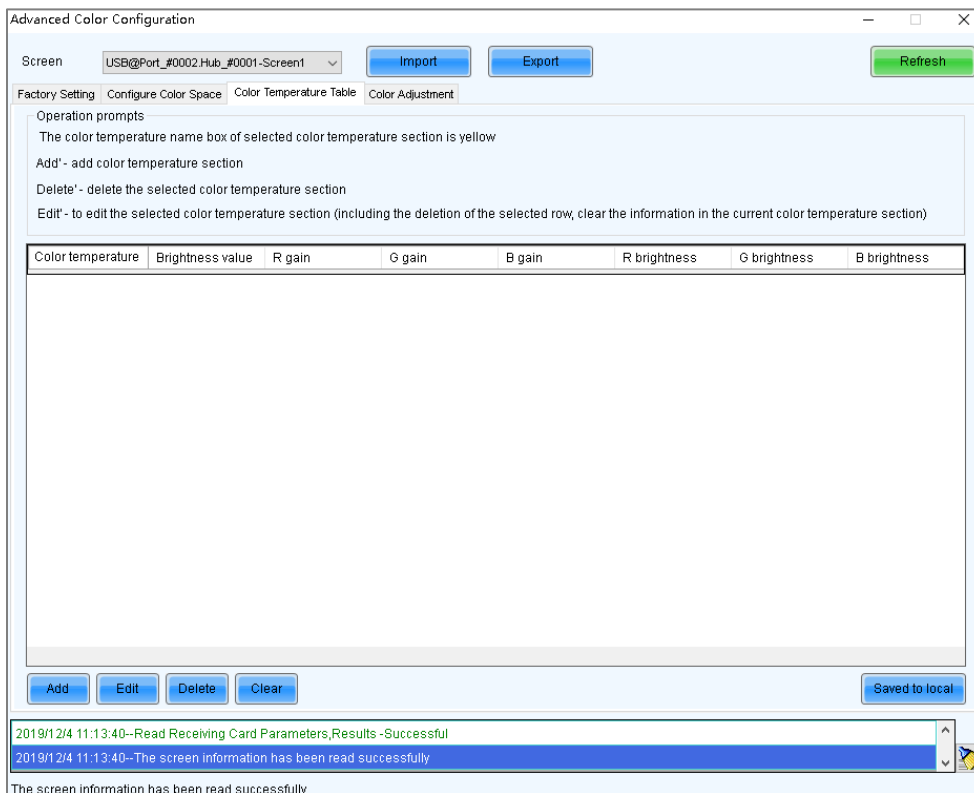

1. Click **Add** to open the dialog box shown in Figure 6-27.
2. Click **Add Brightness** to open the dialog box shown in Figure 6-28.
3. Add color temperature information corresponding to specified brightness values.

Current Gain is a color temperature parameter of modules. The parameter can be set when module chips support current gain. **Brightness Component** is a color temperature parameter of receiving card. If **Synchronize** is selected, the R, G and B parameters will be set to the same value. You can edit, delete and clear the color temperature information if necessary.

4. After the configuration is done, click **Save to local** to save the custom color temperature.

Figure 6-27 Adding color temperature information

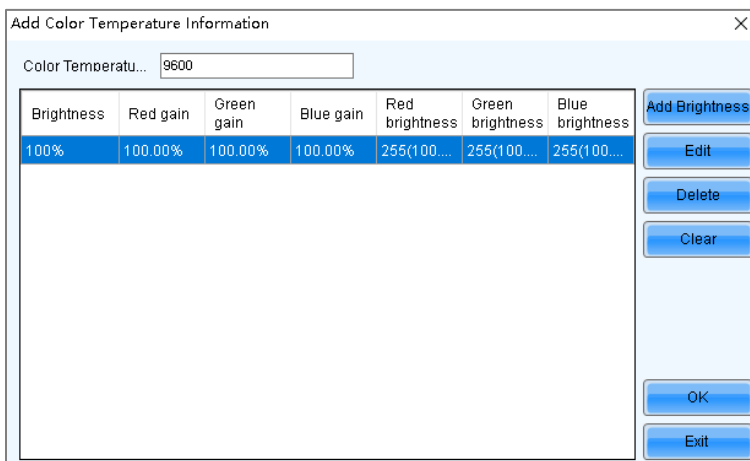
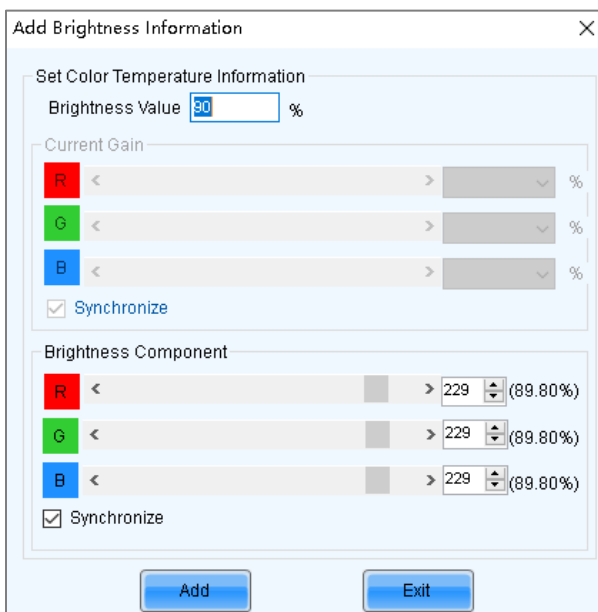
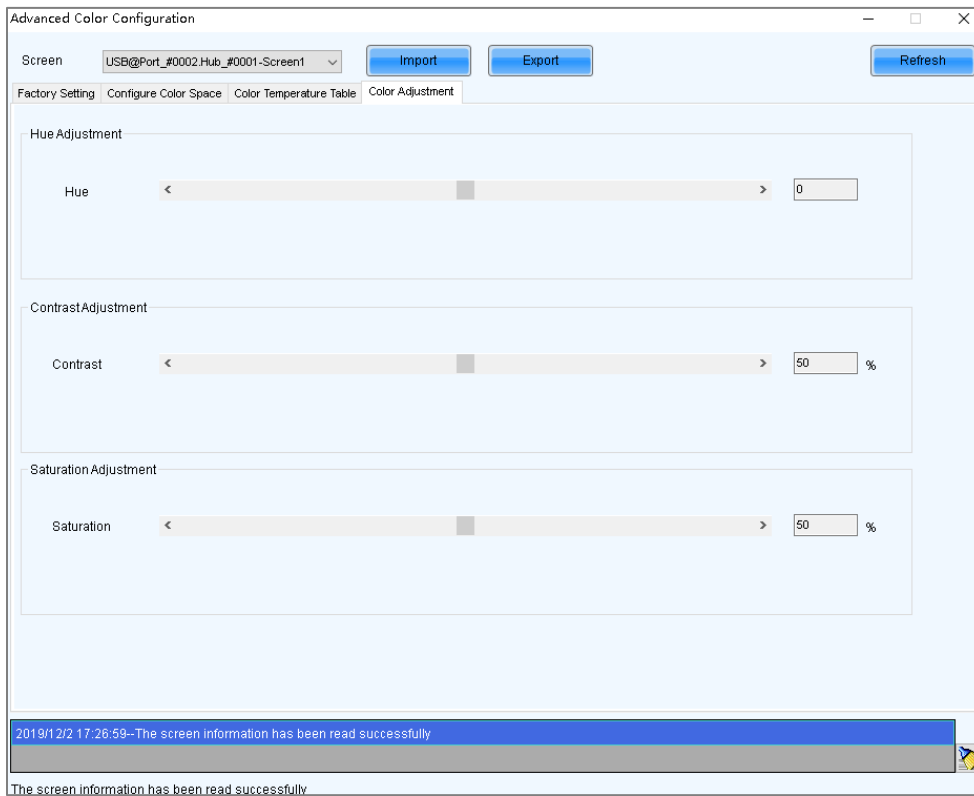

Figure 6-28 Adding brightness information



Step 7 For the NovaPro HD, select **Color Adjustment** to set the hue, contrast and saturation of the screen. This function is not available for other products.

Figure 6-29 Adjusting color



Step 8 (Optional) Click **Export** to save the configuration as a file.

6.7 Adjust Screen Effect

Applications

Enable 18bit+, ClearView and low latency, and set HDR parameters to improve display effect.

Applicable Products

- 18bit+: Applicable to the A5s Plus, A7s Plus, A8, A8s, A10s Plus and DH7512 receiving cards
- ClearView: Applicable to the A8, A8s and A10s Plus receiving cards
- Low latency: Applicable to the A5s Plus, A6s, A8s, A10s Plus and AT60 receiving cards
- HDR: Applicable to the sending cards that support 10-bit or 12-bit input sources

Prerequisites

- During HDR settings, the hardware must support HDR and an HDR10 or HLG input source is also required.
- HDR and ClearView cannot be enabled simultaneously.
- Low latency and 3D function cannot be enabled simultaneously.

Related Information

18bit+ can improve LED display grayscale by 4 times, avoiding grayscale loss due to low brightness and allowing for smoother images.

ClearView make texture, size, and contrast adjustments on different areas of the display image, creating a more realistic image.

Enabling either sending card low latency or receiving card low latency can reduce the delay by one frame. Enabling both can reduce the delay by two frames.

Operating Procedure

Step 1 On the menu bar, choose **User > Advanced Synchronous System User Login**. Enter the password and click **OK**.

The default password is “admin”.

Step 2 Choose **Settings > Adjust screen effect** to open the dialog box shown in [Figure 6-30](#).

Figure 6-30 Screen effect adjustment

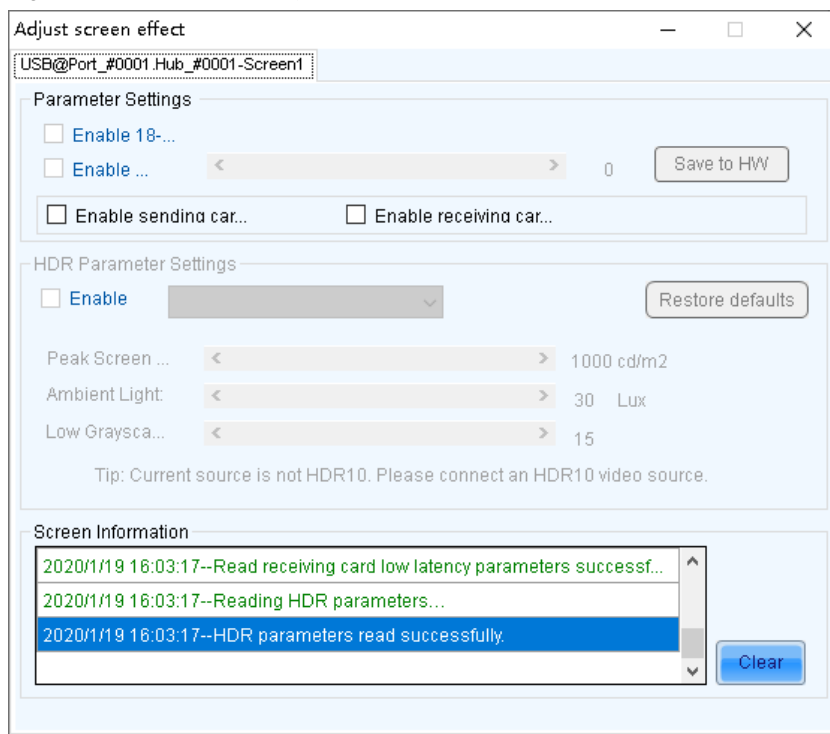

Step 3 Perform any of the following operations as required.

- ✦ **Enable 18-bit mode (18bit+)**
Select **Enable 18-bit mode** and click **Save to HW**.
- ✦ **Enable ClearView**
Select **Enable ClearView**, drag the slider to adjust the value and then click **Save to HW**.
- ✦ **Enable low latency**
Select **Enable sending card low latency** and **Enable receiving card low latency** or either of them, and click **Save to HW**. Enabling either of them can reduce the delay by one frame. Enabling both can reduce the latency by two frames.
- ✦ **Set HDR parameters**
Select **Enable**, select **HDR10** or **HLG** from the drop-down box and complete relevant settings.

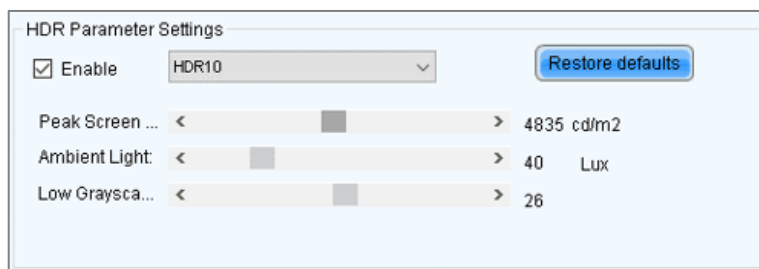

6.8 Set Image Booster Engine

Applications

Using a professional color analyzer (also called light gun or colorimeter) to correct the cabinet's optical factors (such as color gamut, brightness, grayscale, and color temperature) to achieve precise brightness control and accurate color display.

Applicable Products

Applicable to the A8s-N, A10s Plus-N, A10s Pro receiving cards
 Color management is also applicable to the A5s Plus and A7s Plus receiving cards

Prerequisites

When collecting screen data, if you select the auto or custom collection method, CA410-VP427, CA410-P427 or CA410-P427H (use when the brightness exceeds 3000 nits) and the hardware connection must be completed.

Notice

Adjusting the receiving card parameters affects the display effect.

Related Information

When adjusting the effect parameters, it includes the color management, precise grayscale, and 22bit+ functions of the image booster:

+ Color Management

With the help of NovaStar's unique color management algorithm, the this function will realign the LED screen's color gamut to approximate the standard color gamut of BT.709, BT.2020 and D CI-P3, and eventually, the color gamut is adjusted to be consistent with the video source, eliminating color deviation and reproducing natural colors.

+ Precise Grayscale

With the help of professional optical instruments, individually correct the 65,536 levels of grayscale of the driver IC to fix the display problems at low grayscale conditions, such as brightness spikes, brightness dips, color cast and mottling and achieve pinpoint accuracy in grayscale control, allowing for a significant improvement in the quality of LED display images.

+ 22bit+

Harnessing the power of image quality algorithms, the bit depth of low shades of grayscales on the screen is elevated, resulting in an incredible 64-fold surge in dynamic contrast. This process effectively addresses common issues such as grayscale loss and contour lines that arise in case of insufficient grayscale on the screen, allowing for richer grayscale shading and intricate detail presentation for on-screen images.

When you collect the screen data, ensure the colorimeter touches the screen closely. The hardware connection is illustrated in Figure 6-31.

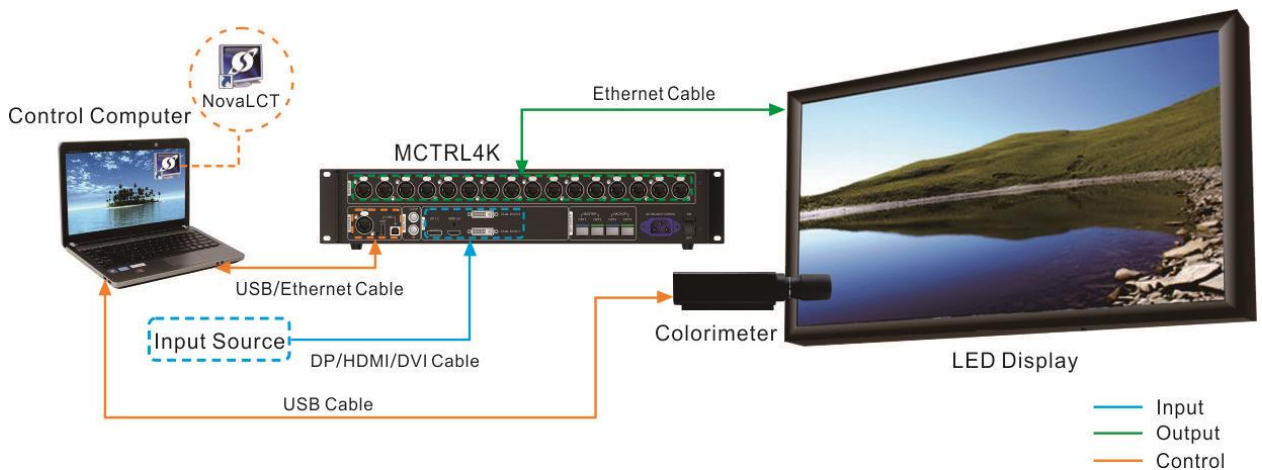

Figure 6-31 Colorimeter connection



Operating Procedure

Step 1 On the menu bar, choose **User > Advanced Synchronous System User Login**. Enter the password and click **Login**.

The default password is "admin".

Step 2 On the main window, click  next to the rightmost function icon to open the drop-down list and then click  Image Booster Engine.

Step 3 On the **Correct Cabinets** screen, click **Please refresh and select device** located at the top left corner.

Figure 6-32 Cabinet correction

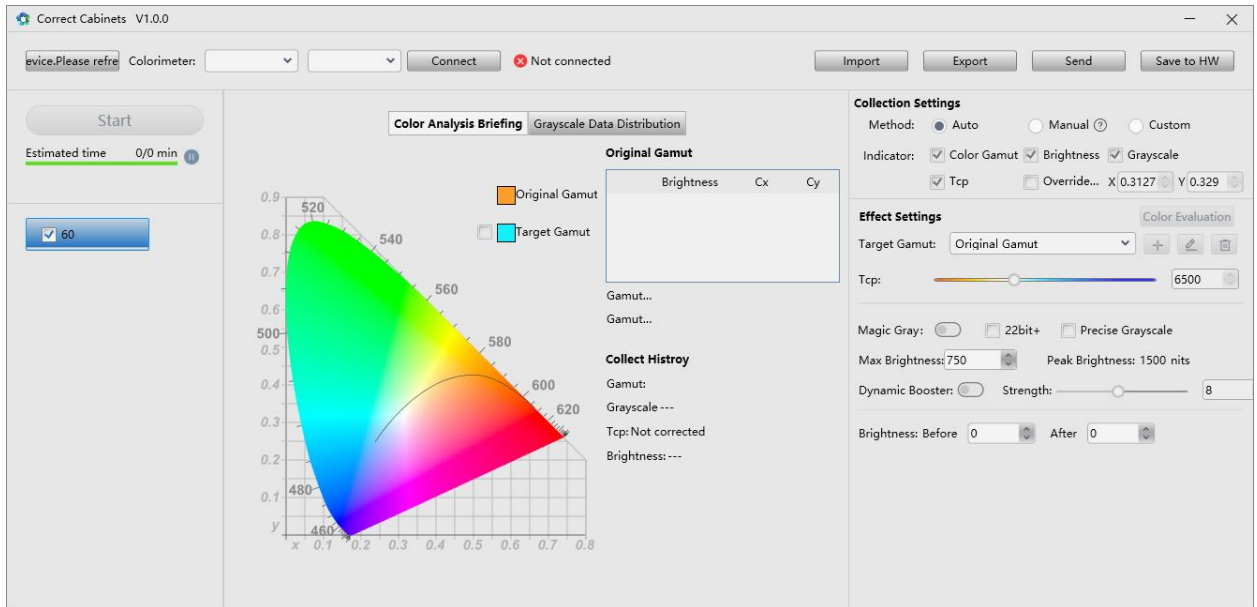

Step 4 In the **Device Management** dialog box, click **Refresh** and select a device from the drop-down options.

Figure 6-33 Device management

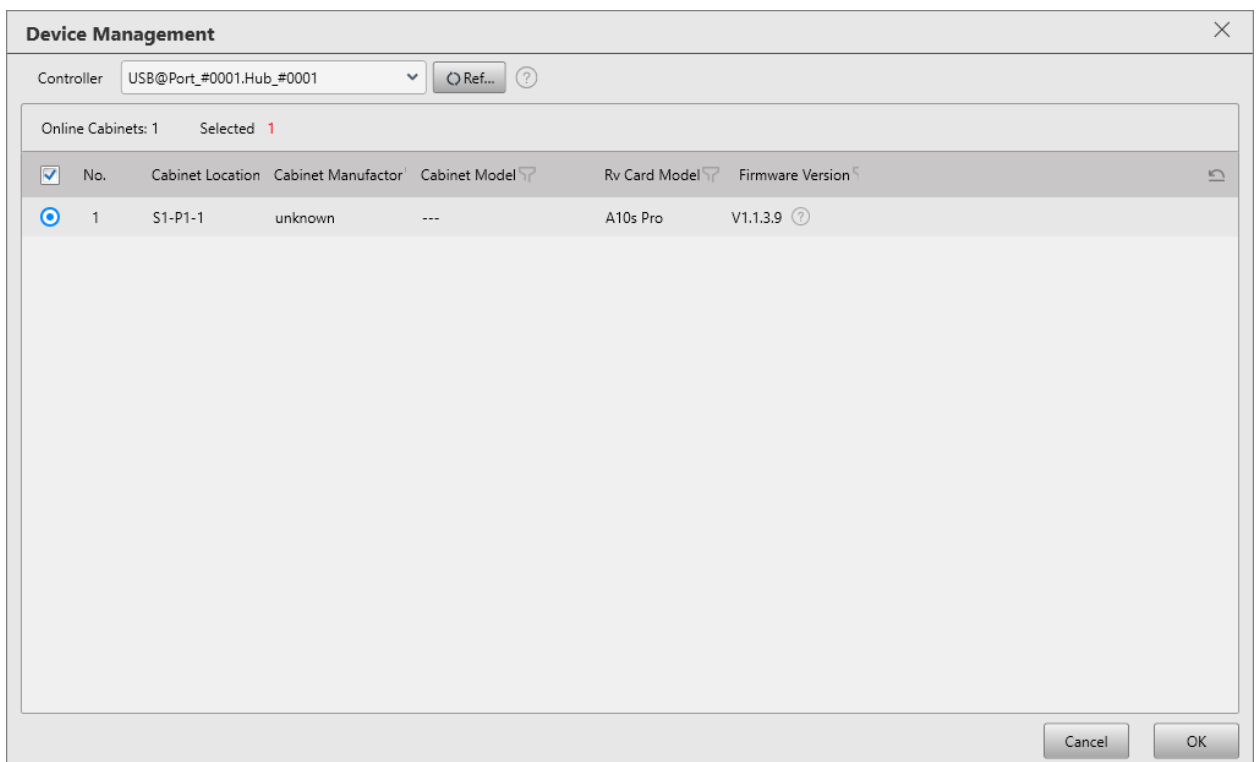

Step 5 Select the cabinet you want to operate and click **OK**.

Step 6 On the left of the screen, select a frame rate.

Step 7 Do the following according to the screen data collection method.

- Automatic
 - a. Set the collection method to **Auto**.
 - b. Select a colorimeter model from the drop-down list.

When the hardware connection is normal, the software will automatically establish communication with the colorimeter after selecting a model.

- c. Click **Start** to automatically collect the screen data through the colorimeter.
- Manual
 - a. Set the collection method to **Manual**.
 - b. Select **Color Gamut**, manually collect the screen data, and then double-click the color gamut value in the table and modify it.
 - c. Select **Brightness** and then set the brightness before and after calibration.
 - d. Click **Start** to make the color gamut and brightness data take effect.
- Custom
 - a. Set the collection method to **Custom**.
 - b. Set the collection indicators.
 - c. Click **Start** to automatically collect the screen data through the colorimeter.

Notes

If an image quality file (.nrf/.vglcx) is available, you can click **Import** to import the image quality data and then adjust the effect parameter.

Step 8 Under the **Effect Settings**, set the following parameters and view the effect on the screen.

- Target gamut

Select a target gamut from the drop-down list. To view the target gamut in the color gamut diagram, select **Target Gamut** in the middle area of the **Correct Cabinets** screen.

Do the following to add custom gamut.

 - a. Click  on the right of the drop-down list to open the adding custom gamut window.

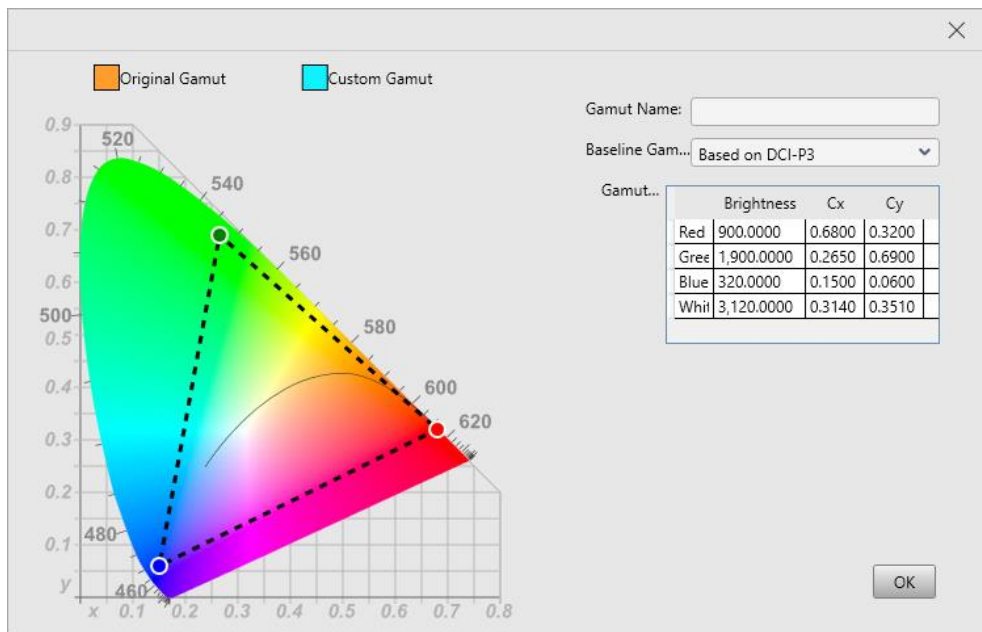

- b. Enter a custom gamut name.
- c. Select a baseline gamut from the drop-down list.
- d. Double-click the cells in the table to change the gamut values or drag the vertex of the black triangle in the color gamut diagram to modify it.
- e. Click **OK** once you are done.

Select a custom gamut and then click  to edit it, or click  to delete it.

- Color Temperature

Drag the slider to set the color temperature, or set the value in the entry box.
- Magic Gray

Toggle switch to enable/disable this function. When this is enabled, **22bit+** and **Precise Grayscale** can be selected.
- Max Brightness

Set the max brightness of the screen in the entry box. **Peak Brightness** is the max brightness measured by the colorimeter.

- **Dynamic Booster**
Toggle switch to enable/disable this function. When this is enabled, drag the slider to adjust the intensity of the Dynamic Booster.
- **Brightness**
Set the brightness before and after calibration to adjust the effect.

Step 9 Click **Export** to save the configuration into a file.

Step 10 Click **Send** to send the configuration to the hardware, or click **Save to HW** to save the configuration to the hardware.

Step 11 If you want to evaluate the color precision, do the following.

1. Click **Color Evaluation**.

Standard Color	Color Value	CIE31(Lxy)	asured Value Before MGMT	DeltaE	Measured Value (Lxy)	DeltaE
	#745244			0		0
	#D9792F			0		0
	#2E3E95			0		0
	#F9F3ED			0		0
	#C49582			0		0
	#455CA3			0		0
	#45924A			0		0
	#C8C8C7			0		0
	#5C799B			0		0
	#B12D38			0		0
	#5B6B45			0		0
	#5A3D67			0		0
	#EBC32F			0		0
	#777978			0		0
	#827FAC			0		0
	#9DBB48			0		0
	#BD5290			0		0
	#535454			0		0
	#5DBAA8			0		0
	#E39E34			0		0
	#0083A2			0		0
	#363637			0		0

2. On the **Evaluate Color Precision** screen, select a gamut from the drop-down list and click **Start Evaluation**.
3. Select **Display Demo**.
4. Click any of the colors in the table and check their effect on the LED screen. Or, you can set the auto color switching interval and then click **Start Demo** to check the effects of all colors on the screen.
 - CIE31: The standard value of brightness, Cx and Cy of the color.
 - Measured Value Before MGMT: The measured value of brightness, Cx and Cy of the color in the original color gamut.
 - Measured Value: The measured value of brightness, Cx and Cy of the color in the target color gamut.
 - DeltaE: The deviation between the measured value and standard value.
5. Deselect **Display Demo**, click **Export Report** to save the evaluation result into a file.

6.9 Batch Check Calibration Effects

Applications

Batch check the effects of disabling calibration, brightness calibration and chroma calibration of multiple devices.

Applicable Products

All receiving cards and sending cards

Prerequisites

None

Related Information

None

Operating Procedure

Step 1 From the menu bar, choose **Tools > More > Device Settings**.

Figure 6-34 Batch checking calibration effects

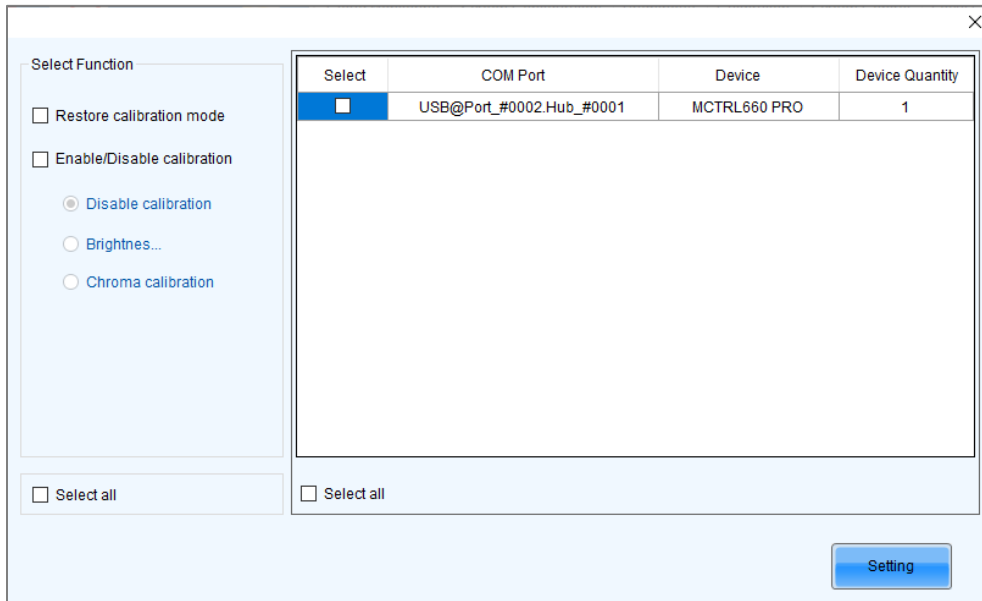

Step 2 In the device list, select the device of which you want to check the calibration effects.

Step 3 Select **Enable/Disable calibration** and click **Setting**.

Step 4 Click **OK** to close the prompt box.

Step 5 Select **Disable calibration**, **Brightness calibration** or **Chroma calibration** and check the corresponding display effects on the LED screen.

7 Screen Monitoring

7.1 Register Screens with VNNOX Care

7.1.1 Register Online Screens

7.1.1.1 Register via Saving Configuration Files (Recommended)

Applications

Register your online screens with VNNOX Care to perform centralized monitoring of the screen working status from a remote place.

Applicable Products

All receiving cards and sending cards

Prerequisites

- You have a valid VNNOX Care account.
- The control PC is connected to the Internet.

Related Information

None

Operating Procedure

Step 1 On the menu bar, choose **User > Advanced Synchronous System User Login**. Enter the password and click **Login**.

The default password is "admin".



Step 2 Click **Screen Configuration** or choose **Settings > Screen Configuration** from the menu bar to open the dialog box shown in Figure 7-1.

Figure 7-1 Screen configuration method

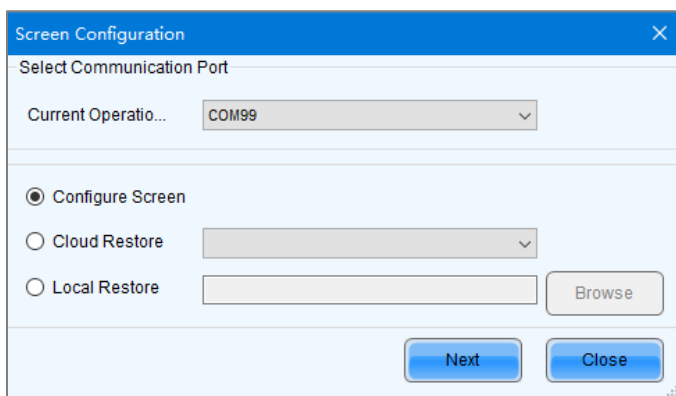

Step 3 Choose a communication port.

Step 4 Select **Configure Screen** and click **Next**.

Step 5 On the **Screen Configuration** page, click **Save System Configuration File** to open the dialog box shown in Figure 7-2.

Figure 7-2 Saving configuration files

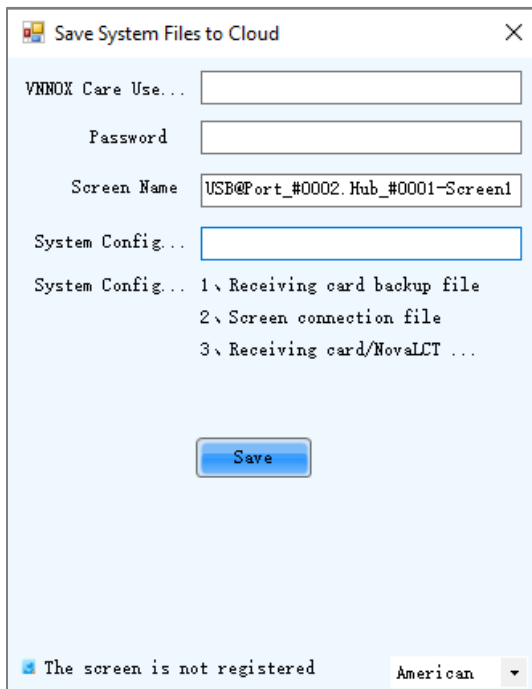

- Step 6 Enter your VNNOX Care user name and password, set a screen name and system configuration file name, and select a server node at the bottom right.
- Step 7 After the settings, click **Save**.
- Step 8 After successful saving, close the prompt box.

Notes

During registration, NovaLCT will automatically enable **Automatic Refresh** and **Link to NovaiCare** in the monitoring configuration. If you want to set the refresh period, please see [7.2 View and Configure Monitoring](#).

7.1.1.2 Register via Function Buttons

Applications

Register your online screens with VNNOX Care, or modify the earlier registration information and then re-register the screens with VNNOX Care to perform centralized monitoring of the screen working status from a remote place.

Applicable Products

All receiving cards and sending cards

Prerequisites

- You have a valid VNNOX Care account.
- The control PC is connected to the Internet.

Related Information

When multiple screens are connected to the control PC, all these screens will be registered with VNNOX Care.

Operating Procedure



Step 1 Click  or choose **Tools > Monitoring** from the menu bar to open the monitoring page.

You can also right click  on the desktop taskbar and select **Open MonitorSite** to open the monitoring page.

Figure 7-3 Monitoring



- Step 2 Click **Configuration** to open the **MonitorSite – Settings** page.
- Step 3 On the **Refresh Period** tab page, select **Automatic Refresh** and set the refresh period.
- Step 4 Set the rereading times. 2 is recommended.
- Step 5 Select **Link to NovaiCare**, click **Save** and then **OK**.

Figure 7-4 Monitoring configuration

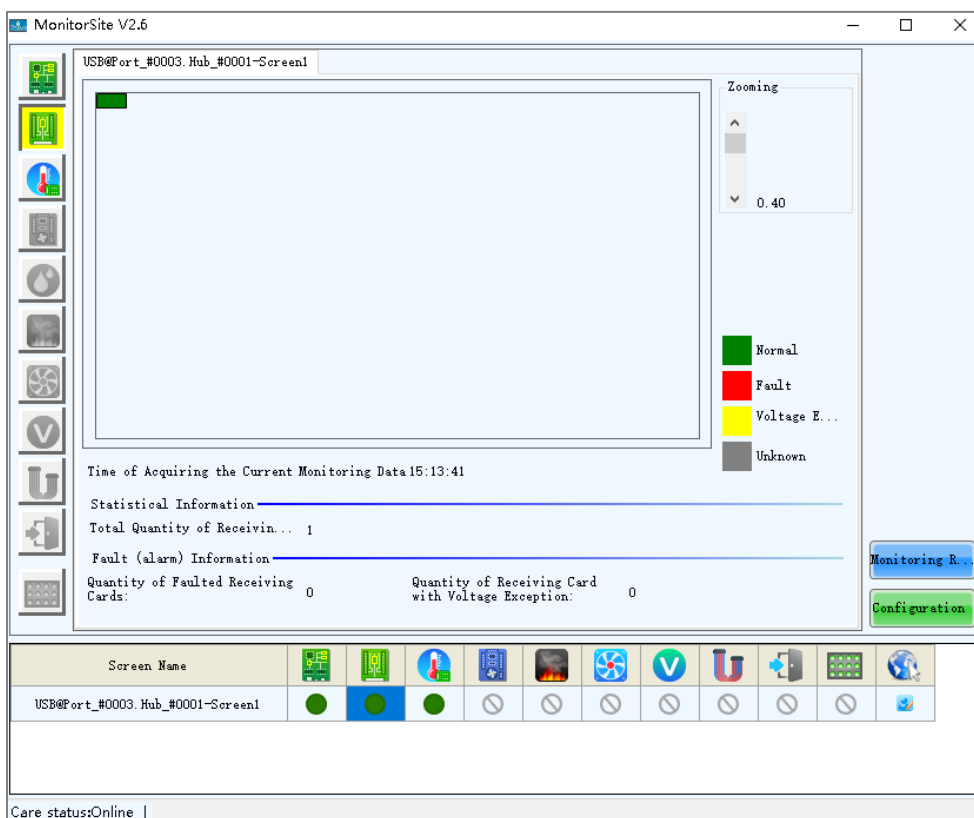
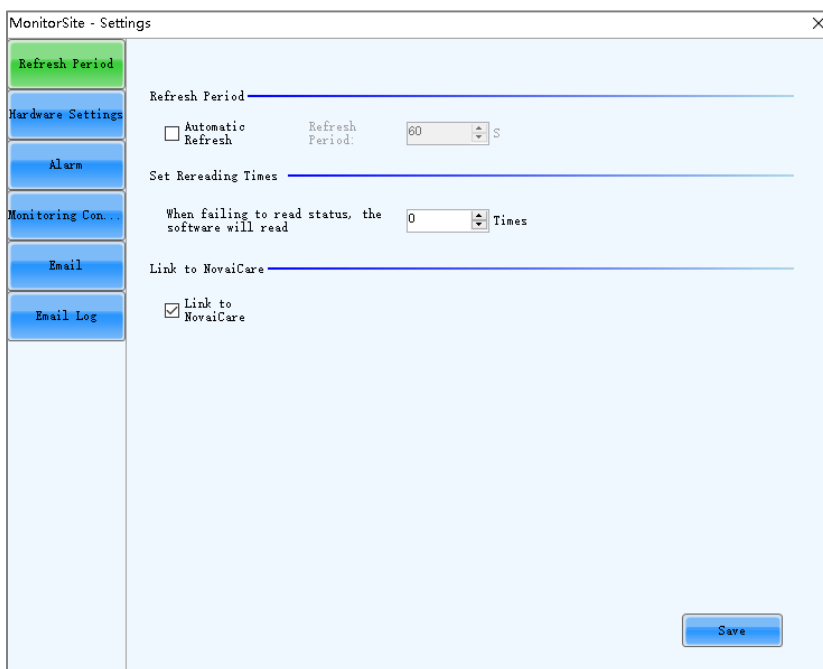

- Step 6 On the desktop taskbar, right click , select **Exit** and click **OK**.



- Step 7 Click **Monitoring** to start the monitoring function again.



Step 8 Click **Cloud Monitoring** or choose **Settings > Cloud Monitoring** from the menu bar.

Step 9 Click **Register in VNNOX Care**.

Step 10 Click **Modify Registration**.

Figure 7-5 Registration

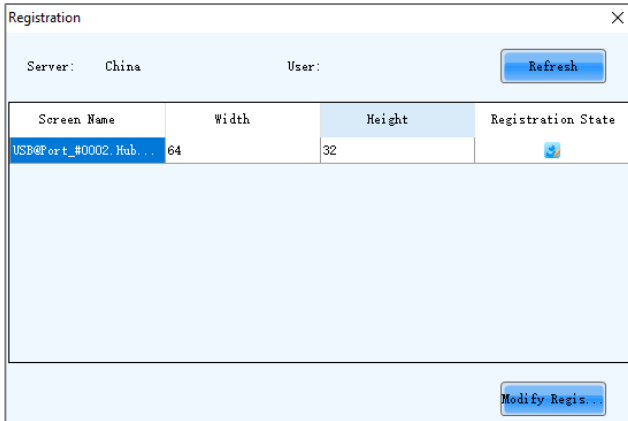

Step 11 Select a server node, enter your VNNOX Care user name and password, and set the screen name.

Figure 7-6 Registration information

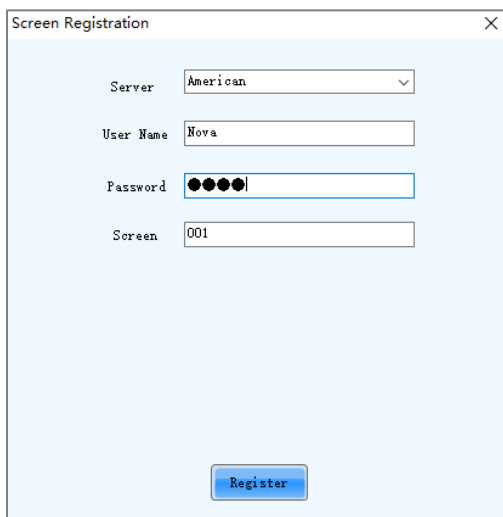

Step 12 Click **Register**.

Step 13 After successful registration, click **OK** to close the prompt box.

7.1.2 Register Offline Screens

7.1.2.1 Register by Using Local Backup Files (Recommended)

Applications

During the process of saving the screen configuration data, save the configuration files to the local PC. When the control PC can access the Internet normally, use the backup files to register the screens with VNNOX Care.

Applicable Products

All receiving cards and sending cards

Prerequisites

You have a valid VNNOX Care account.

Related Information

None

Operating Procedure

Step 1 On the menu bar, choose **User > Advanced Synchronous System User Login**. Enter the password and click **Login**.

The default password is "admin".



Step 2 Click **Screen Configuration** or choose **Settings > Screen Configuration** from the menu bar to open the dialog box shown in [Figure 7-7](#).

Figure 7-7 Screen configuration method

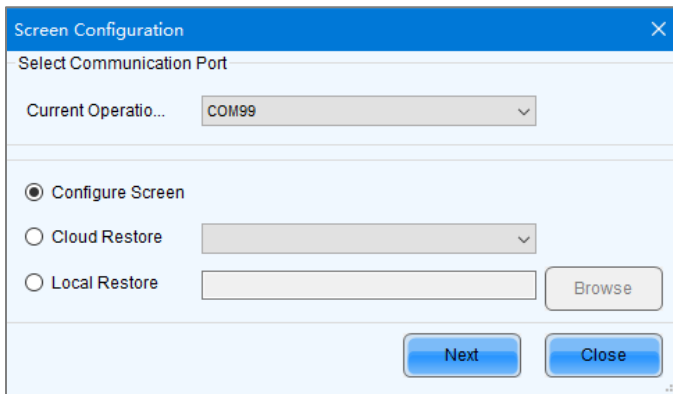

Step 3 Choose a communication port.

Step 4 Select **Configure Screen** and click **Next**.

Step 5 On the **Screen Configuration** page, click **Save**.

Step 6 After successful saving, click **OK** to save the backup file to the local computer.

This step is related with the configuration of the save function. See [11.1 Configure the Save Function](#).

Figure 7-8 Successful saving

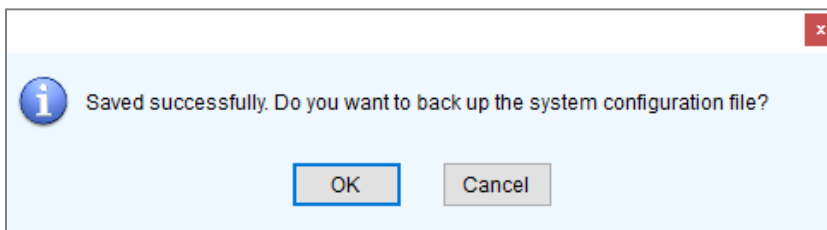

Step 7 After successful saving, click **Close**.

For devices with the same SN, NovaLCT uses the new file to overwrite the old file.

Figure 7-9 Saved successfully

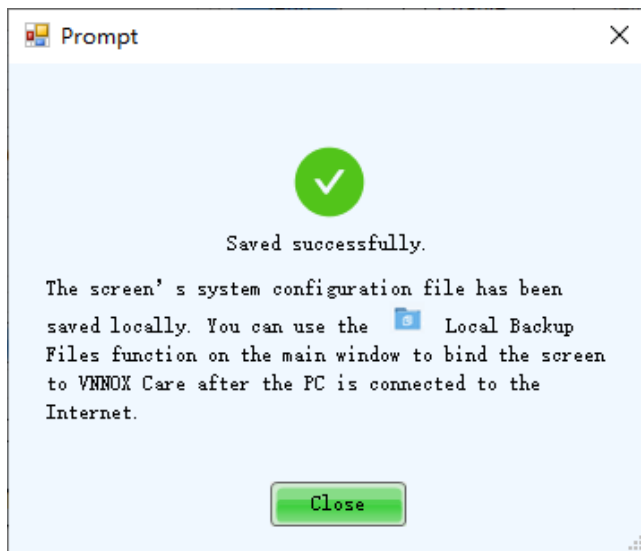

Step 8 When the control PC can access the Internet normally, click **Cloud Monitoring** on the main window and then click **Local Backup Files** to open the dialog box shown in Figure 7-10.

Figure 7-10 Local backup files

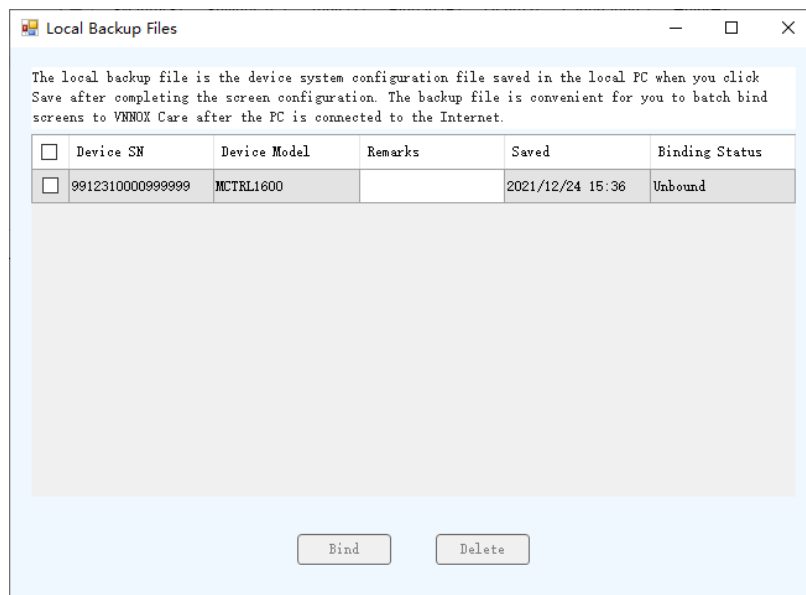

Step 9 Enter a remark.

The remark will be the name of the successfully bound screen. If the remark is empty, the device SN will be the screen name.

Step 10 Select the backup file records of one or multiple devices and click **Bind**.

Step 11 Enter your VNNOX Care user name and password, select a server node and click **OK**.

After successful binding, the **Binding Status** of the corresponding device in the **Local Backup Files** dialog box becomes **Bound**.

Figure 7-11 Binding to VNNOX Care

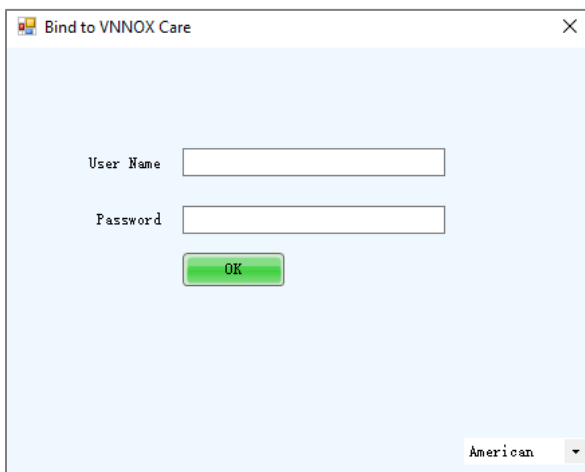

Related Operations



Both in the logged in and not logged in statuses, you can click **Cloud Monitoring** and then **Local Backup Files** to open its dialog box and check the device binding status and delete configuration files.

7.1.2.2 Register by Using Screen Monitoring Data

Applications

Export the configuration file of an offline screen. When the control PC can access the Internet normally, import the exported configuration file to VNNOX Care to complete screen registration.

Applicable Products

All receiving cards and sending cards

Prerequisites

You have a valid VNNOX Care account.

Related Information

None

Operating Procedure

Step 1 On the menu bar, choose **User > Advanced Synchronous System User Login**. Enter the password and click **Login**.

The default password is “admin”.



Step 2 Click **Screen Configuration** or choose **Settings > Screen Configuration** from the menu bar to open the dialog box shown in [Figure 7-12](#).

Figure 7-12 Screen configuration method

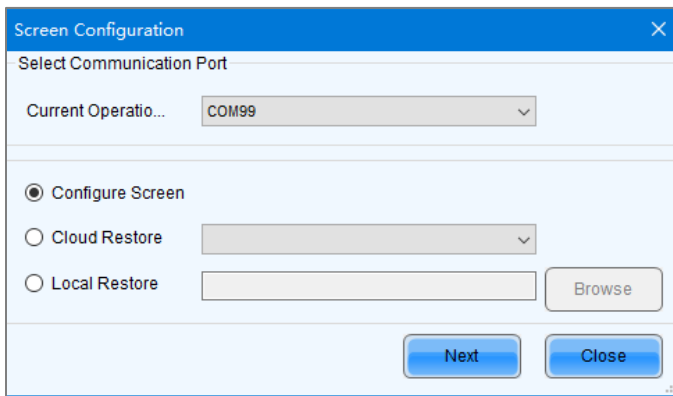

Step 3 Choose a communication port.

Step 4 Select **Configure Screen** and click **Next**.

Step 5 On the **Screen Configuration** page, click **Export Screen Monitoring Data** to open the dialog box shown in [Figure 7-13](#).

Figure 7-13 Exporting screen monitoring data

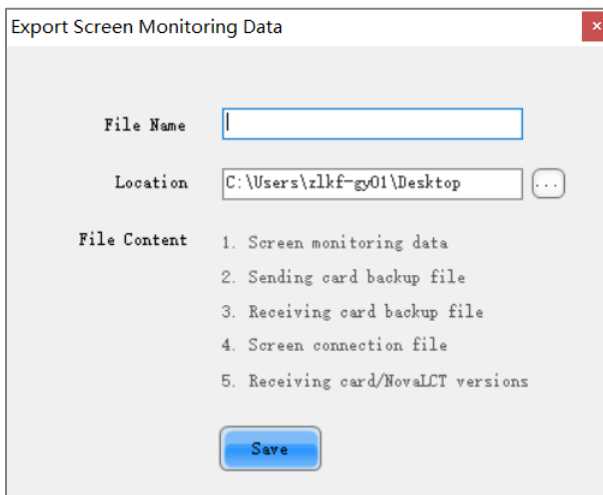

Step 6 Set a file name, click  to select a location and click **Save**.

Step 7 After successful saving, click **OK** to close the prompt box.

Step 8 When the control PC can access the Internet normally, log in to VNNOX Care.

Step 9 Go to **My Services > Screen Management** to enter the screen management page.

Step 10 Click **Add Screen**, select the exported screen monitoring data file and click **Upload**.

7.2 View and Configure Monitoring

Applications

View the monitoring information and configure the monitoring parameters to monitor the statuses of sending cards, receiving cards, receiving card temperatures, monitoring devices, as well as humidity, smoke, fans, power supplies, cables, cabinet doors, modules, iCare within the control system, in order to detect abnormalities and handle them in time.

Applicable Products

- Use monitoring card for monitoring: Applicable to the MON300 monitoring card. This card works with the MRV320 and MRV560 receiving cards.
- Use smart modules for monitoring: Applicable to the A4, A4s, A5, A5s, A5s Plus, A7, A7s, A7s Plus, A8, A8s, A9s, A10s Plus, XC200, XC100 and B4s receiving cards. The smart module monitoring function is a customized function of the receiving cards.

- Use hub products for monitoring: Applicable to the A4, A4s, A5, A5s, A7, A7s, A8, A8s, A9s, A10s Plus, XC200 and XC100 receiving cards. Using hub product for monitoring is an optional function of the receiving cards.

Prerequisites

- If you want to use the monitoring function of monitoring card, a monitoring card should be used between the module and receiving card.
- If you want to use the email service, the SMTP server address and port must be known in advance.

Related Information

When the monitoring card is used, hub monitoring and smart module cannot be used. Hub monitoring and smart module can be used simultaneously.

Operating Procedure



Step 1 Click **Monitoring** or choose **Tools > Monitoring** from the menu bar to open the monitoring page.



You can also right click  on the desktop taskbar and select **Open MonitorSite** to open the monitoring page.

Figure 7-14 Monitoring

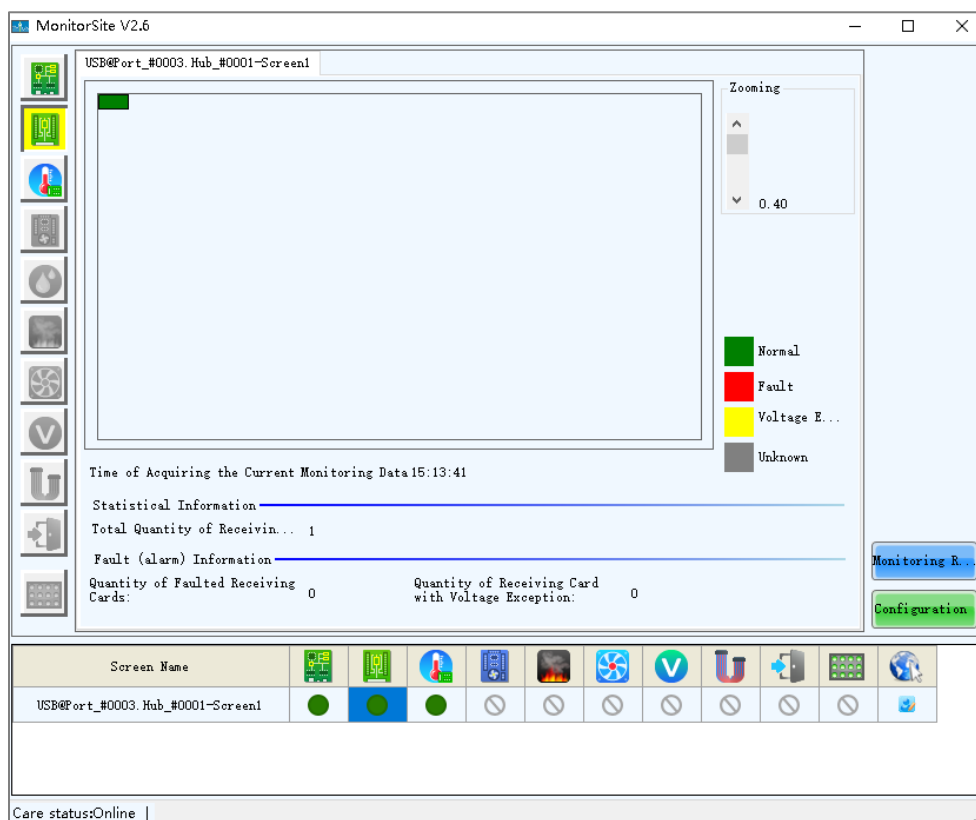

Notes

- Click **Monitoring Refresh** to manually refresh the monitoring information.
- On the desktop taskbar, right click  and select **Reload Screen** to refresh the receiving card topology diagram.

Step 2 Click the monitoring item on the left or at the bottom of the page to view the detailed monitoring information.

Step 3 Click **Configuration** to set the monitoring parameters.

✚ **Refresh Period**

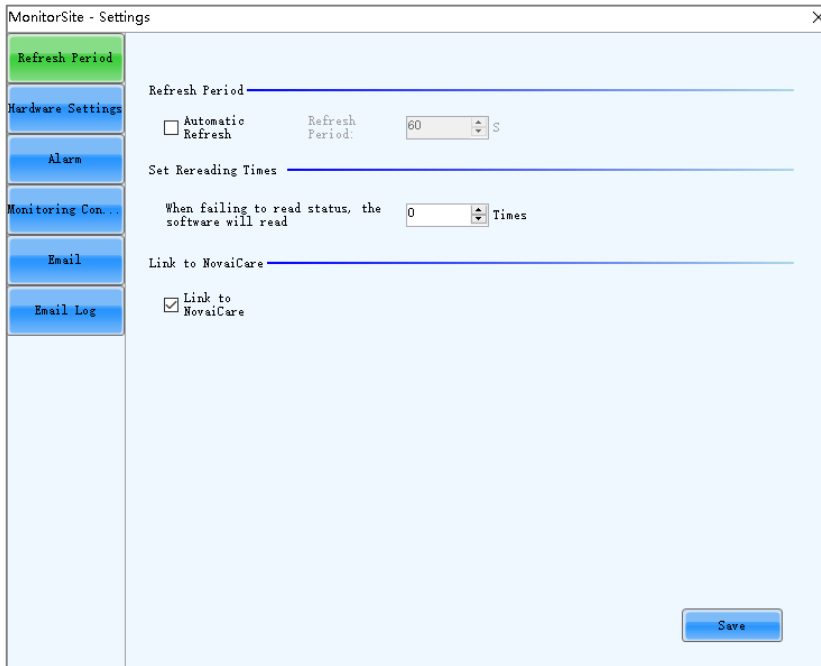

Set the necessary items as follows and click **Save** to save the settings.

- Select **Automatic Refresh** to set the refresh period. The monitoring information will be refreshed based on the set time period. If the screen is registered with iCare, this item must be selected.
- Set the reread times when the reading of the monitoring information from the receiving card fails.
- Select **Link to NovaiCare** to enable iCare to get the monitoring information.

Hardware Settings

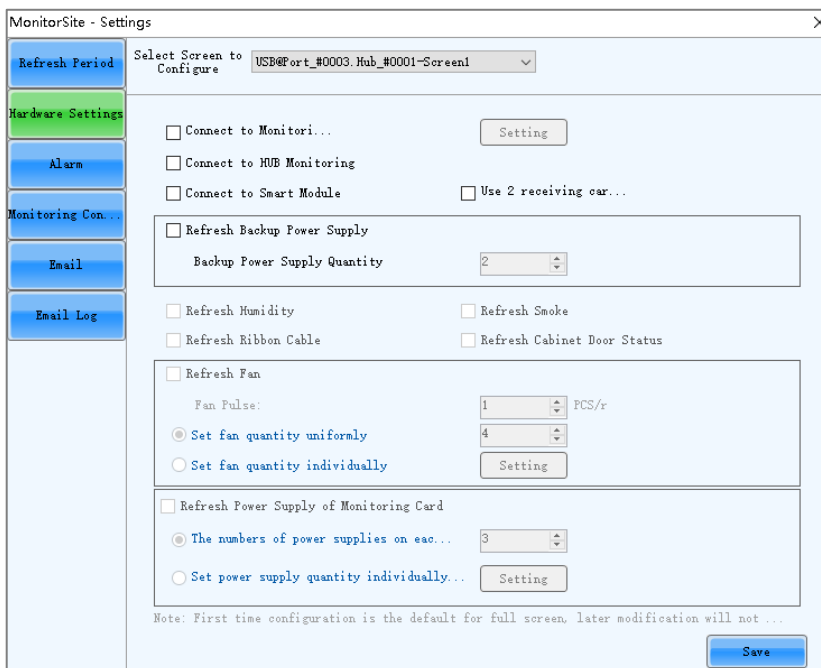

Set the necessary items as follows and click **Save** to save the settings.

- Select **Connect to Monitoring Card** and set the monitoring items. Click **Setting** to set the number of monitoring cards connected to each cabinet. The number is 0 or 1.
- Select **Connect to HUB Monitoring** and set the monitoring items.
- Select **Connect to Smart Module** and set the monitoring items.
- Select **Connect to HUB Monitoring** and **Connect to Smart Module**, and then set the monitoring items.

Alarm

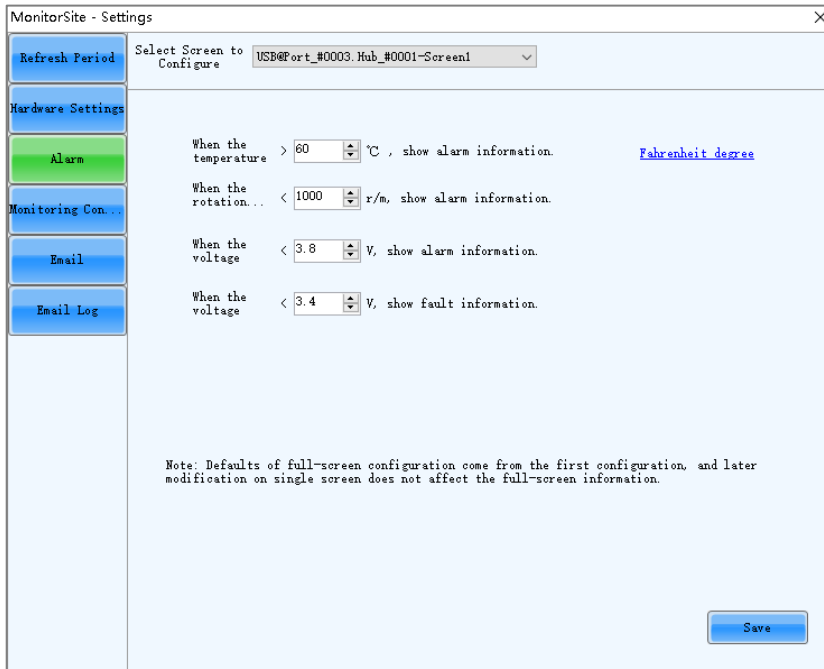

Set the alarm thresholds for temperature, fan rotating speed and voltage. When the threshold value is exceeded, faults or alarms will be displayed. After the configuration is done, click **Save** to save the settings.

Monitoring Control

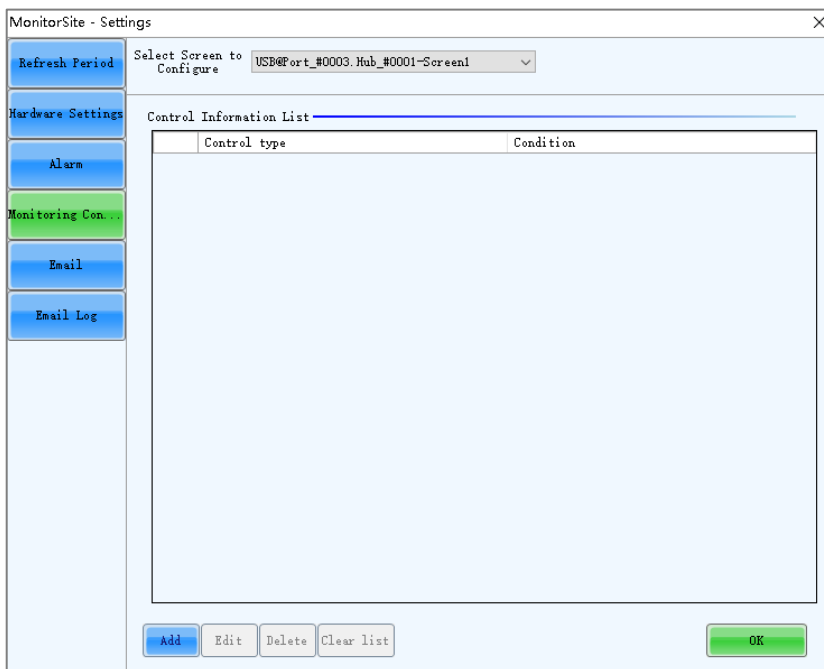

Set the rules for automatic control of smoke, temperature and dual backup power supply. If the control type is set to smoke, a multifunction card must be configured in advance. After the settings are done, click **OK**.

Email

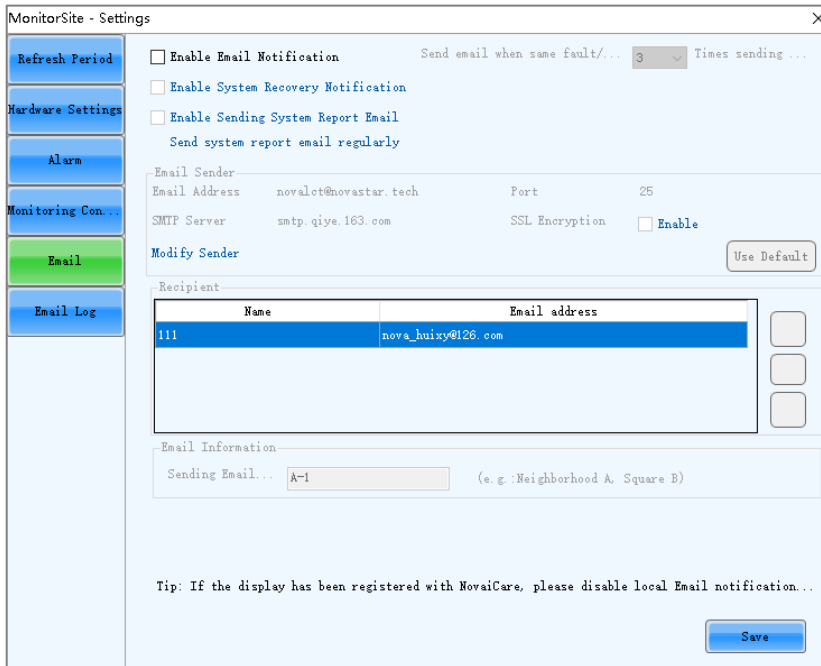

Select **Enable Email Notification**. Set the necessary items as follows and click **Save** to save the settings.

- Set the condition for sending an email notification, namely how many times the same fault or alarm occurs consecutively.
- Select **Enable System Recovery Notification** to send email notification when the fault or alarm recovers.
- Select **Enable Sending System Report Email** and click **Send system report email regularly** to set the email sending period and time.
- Click **Modify Sender** to change the email service related settings.
- Add, edit or delete the recipients.
- Set where the email is sent from.

✦ Email Log

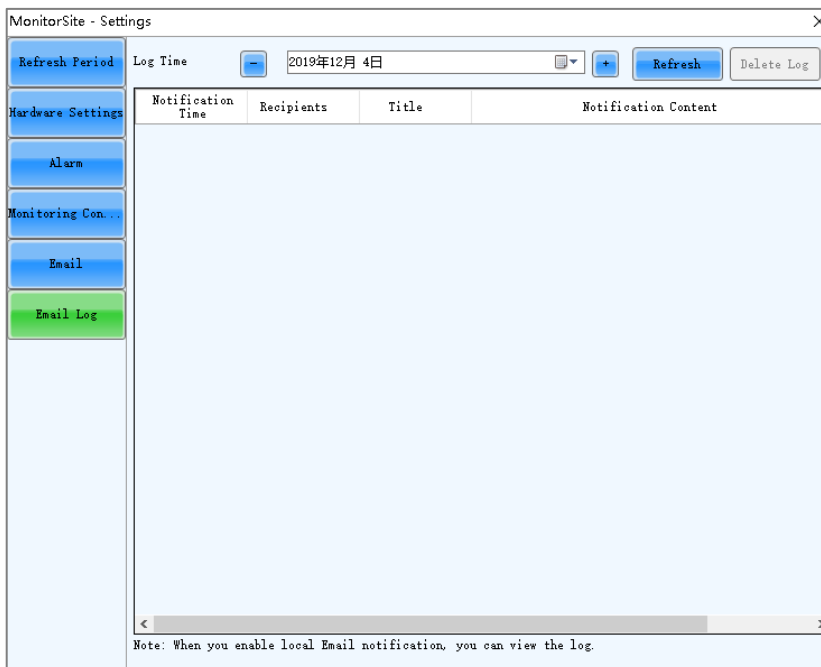

View or delete the email log. Enable the email notification function before log operations.

8 Screen Management

8.1 Multi-function Card Management

Applications

Configure the multifunction card, and perform power management, monitoring data viewing, peripheral settings, program loading and audio management.

Applicable Products

The MFN300 multifunction card

Prerequisites

Hardware connections for the multifunction card are done.

Related Information

None

Operating Procedure

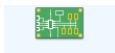

Step 1 Click **Multi-function Card** or choose **Settings > Multi-function Card** from the menu bar.

Figure 8-1 Multifunction card management

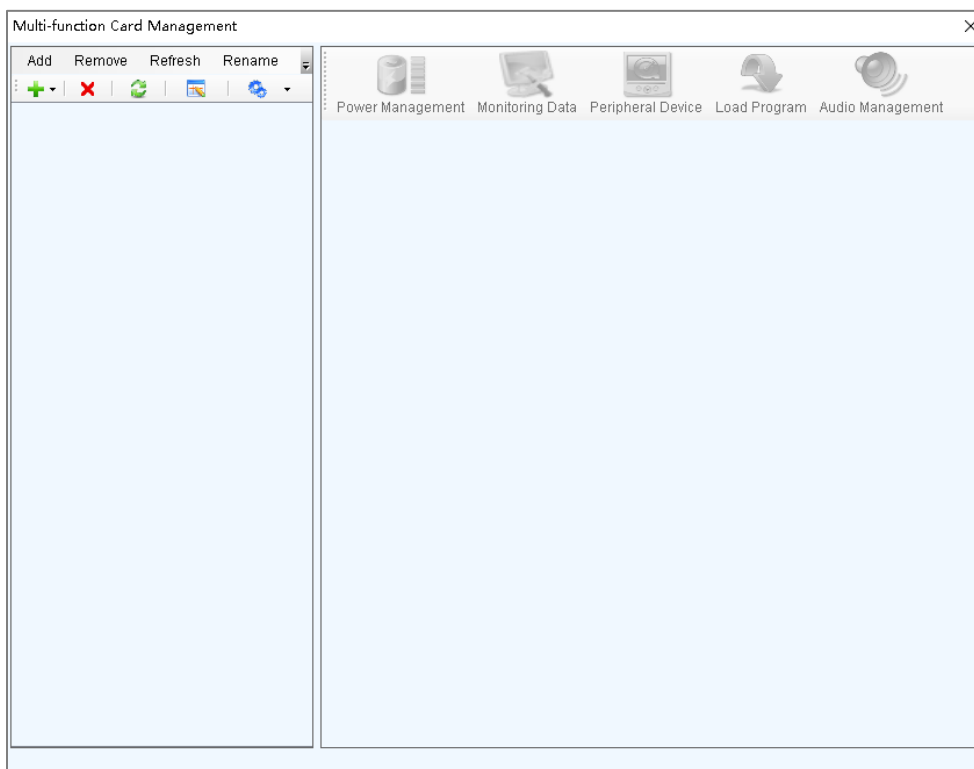

Step 2 Click **Add** and select the connection type for the multifunction card.

- **Serial Port Connection:** Select this option when the serial port of the multifunction card is connected to the USB port of the PC.
- **Ethernet Port Connection:** Select this option when the Ethernet port of the multifunction card is connected to that of the sending card or receiving card.

You can also remove, refresh or rename the added connections.

For serial port connection, you can perform the following operations:

- **Modify Serial Port:** Change the current serial port to the one that is not configured for the multifunction card.
- **Replace Serial Port:** Replace the current serial port with the one that is connected with the multifunction card.

Step 3 For serial port connection, choose a communication port and click **OK**.

For Ethernet port connection, choose a communication port and set other parameters as shown in [Figure 8-2](#), and then click **OK**.

Figure 8-2 Adding multifunction cards

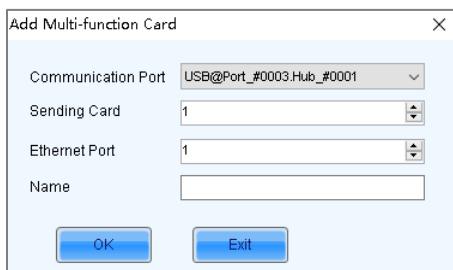

[Figure 8-3](#) shows the user interface of an Ethernet port connection that is added successfully. The following procedure takes Ethernet port connection as an example to illustrate the function.

Figure 8-3 Ethernet port connection

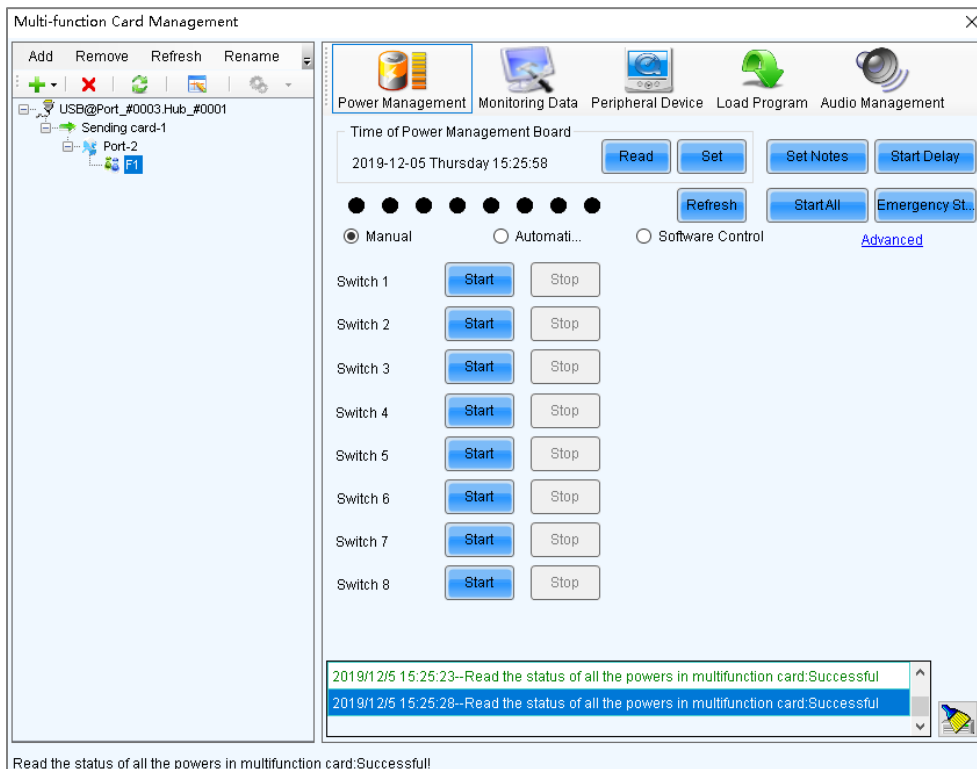

Step 4 Use any of the following functions as needed.

➤ **Power Management**

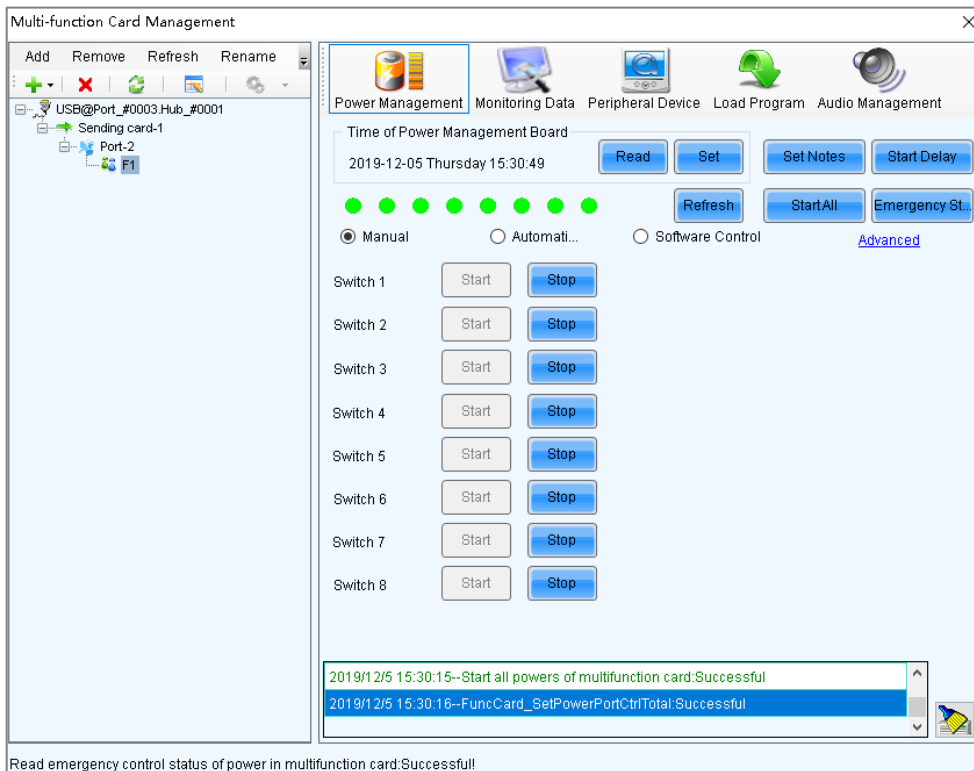

- Read: Read the time from the multifunction card.
- Set: Set the multifunction card time to the PC time.
- Set Notes: Write notes for the power supplies.
- Start Delay: Set the delay time for powering on the multifunction card.
- Refresh: Read back the multifunction card information.
- Start All: Start all power supplies.
- Emergency Stop: Stop all power supplies. When the emergency stop operation is executed, automatic control is invalid.
- Manual: Start or stop the power supplies manually.
- Automatic Control: Set the auto start and stop time for the power supplies.
- Software Control: Set the power control schedule. Click **Edit** to customize the power control list. Click **View Log** to view the power control log.
- Advanced: Set the time for the automatic time synchronization between the multifunction card and PC.

+ Monitoring Data

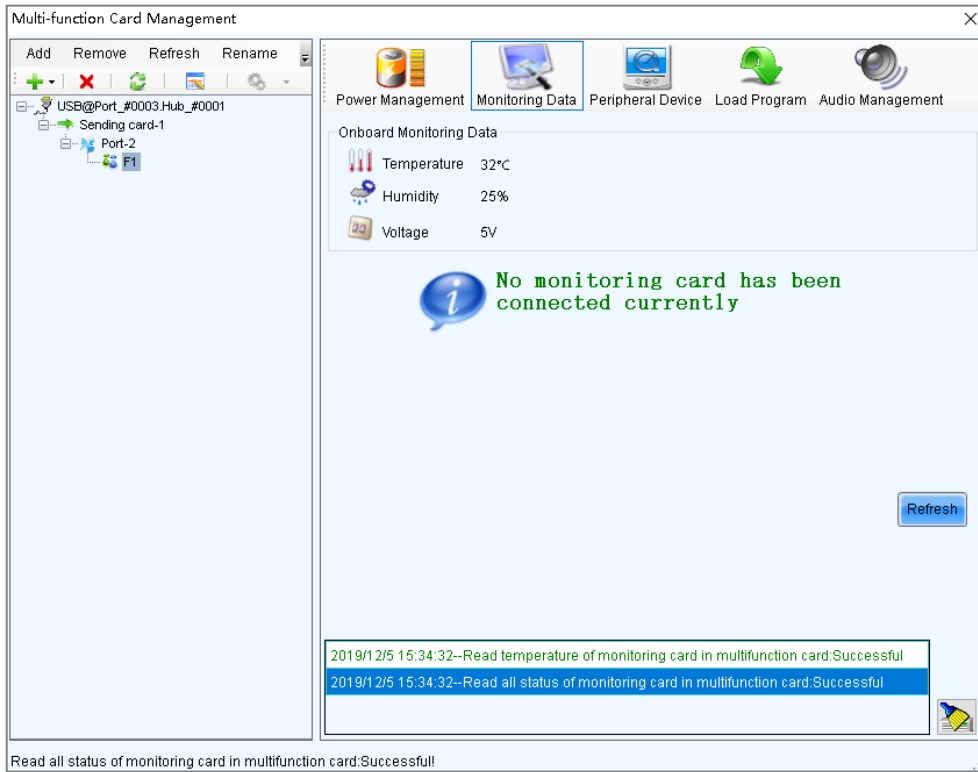

View the monitoring data of both multifunction card itself and its connected monitoring card.

Peripheral Device

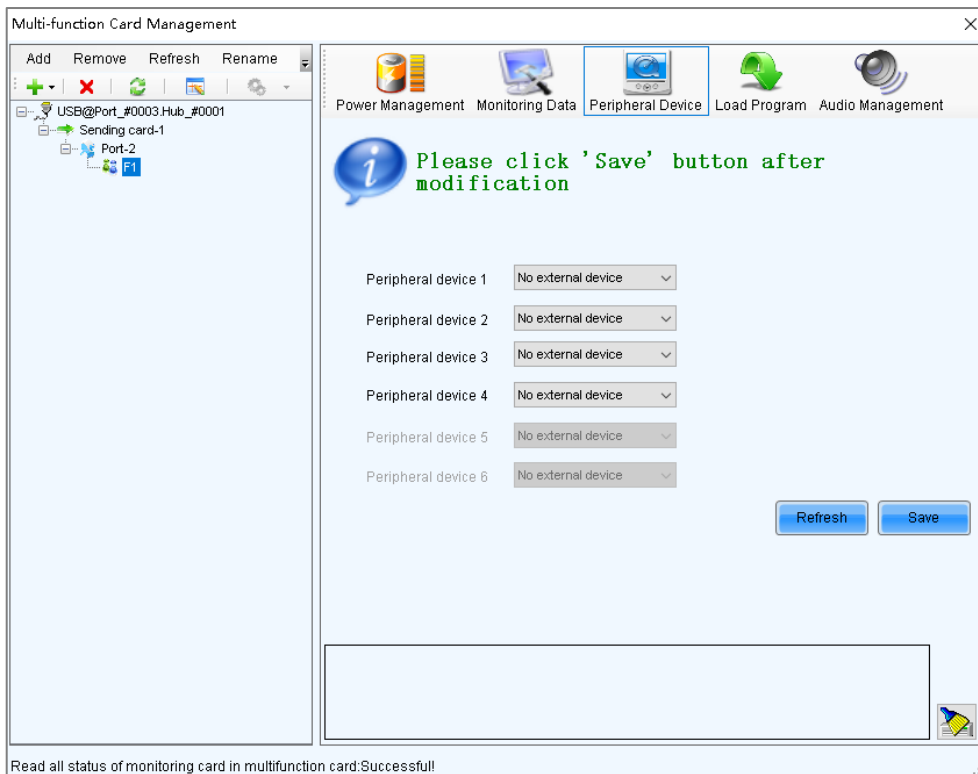

Add the peripheral devices connected to the multifunction card, including the light sensors and external 3D emitters.

Load Program

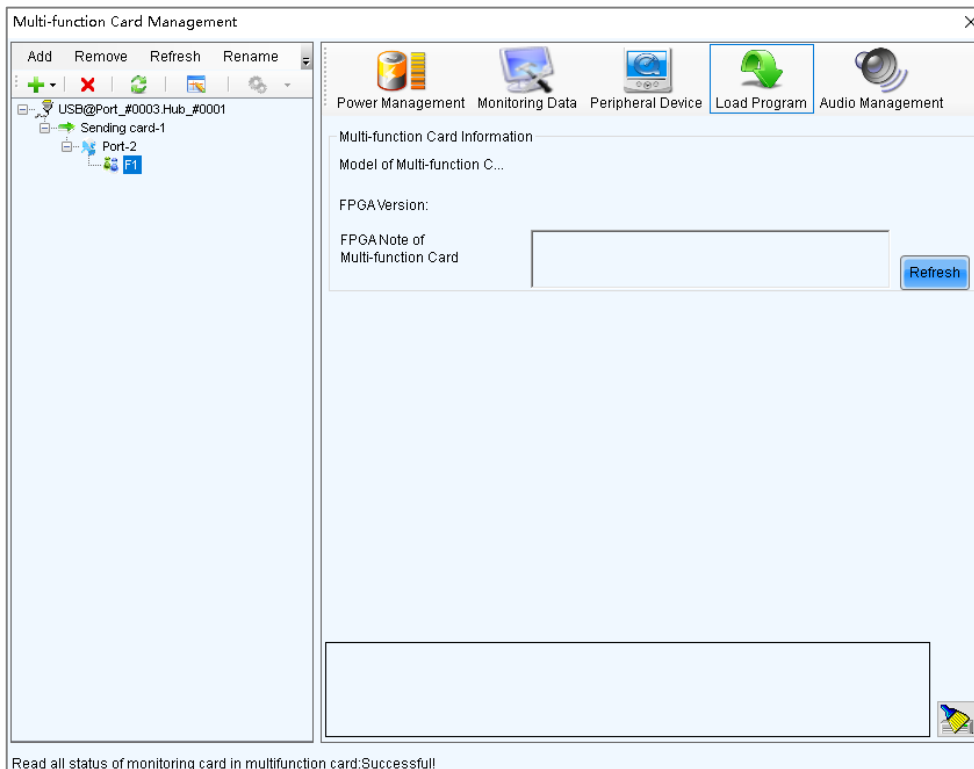

Click **Refresh** to view the multifunction card model, FPGA version and FPGA note.

Type “admin” to access the options for program loading.

- a. Select **Load program for selected Multi-function Card** or **Load all programs for Multi-function Card**.
- b. Click **Browse** to select the program package.
- c. Click **Change** to load the selected program.
- d. Click **Exit** to hide the program loading options.

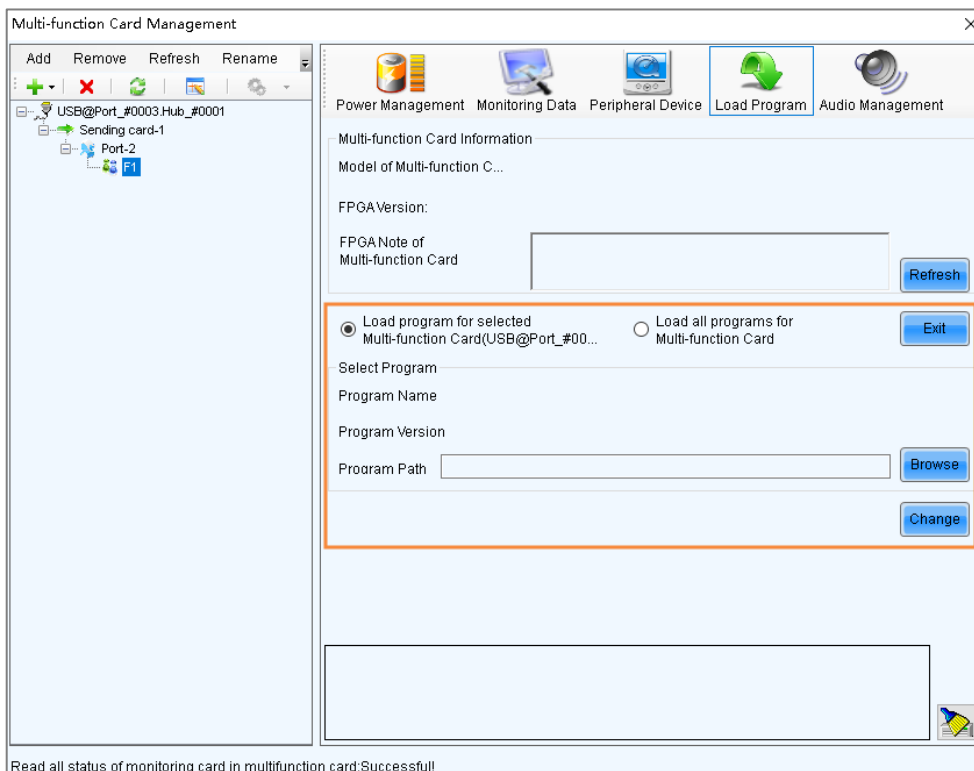

Audio Management

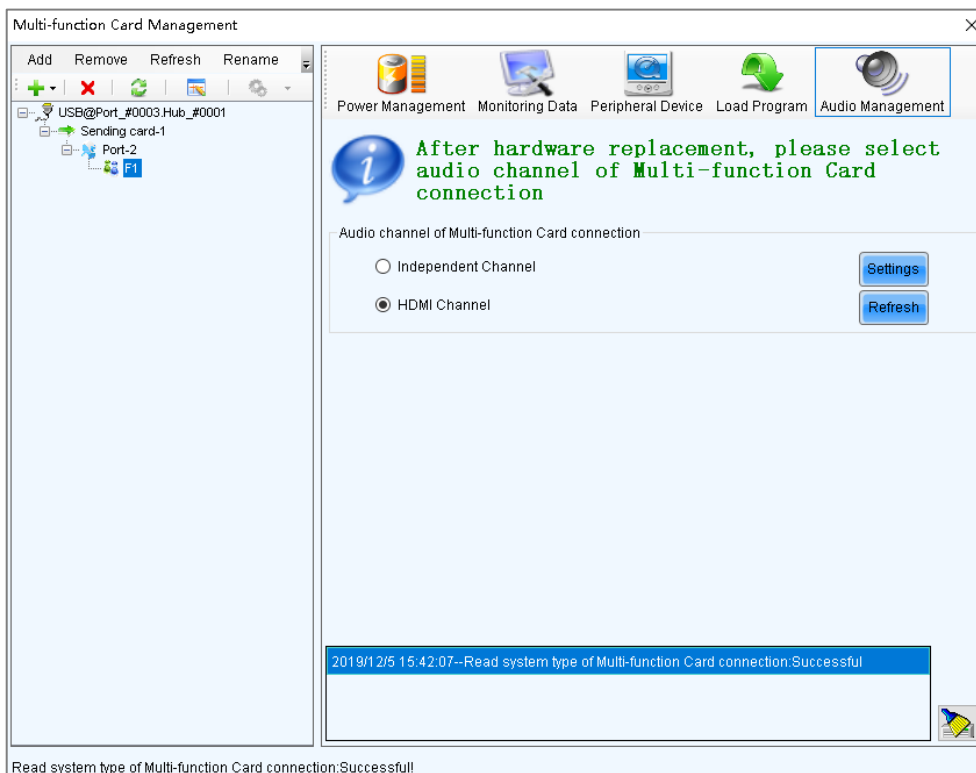

Set the audio channel connected to the multifunction card, including the independent channel and HDMI channel.

8.2 Multiple-screen Management

Applications

Combine multiple screens into a combined screen, allowing for easier brightness adjustment, screen calibration and monitoring configuration, and higher working efficiency.

Applicable Products

All receiving cards and sending cards

Prerequisites

None

Related Information

The combined screen supports both auto and manual brightness adjustment.

Operating Procedure

- Step 1 On the menu bar, choose **User > Advanced Synchronous System User Login**. Enter the password and click **OK**.
The default password is “admin”.
- Step 2 Choose **Settings > Multiple-screen Management**.

Figure 8-4 Multi-screen management

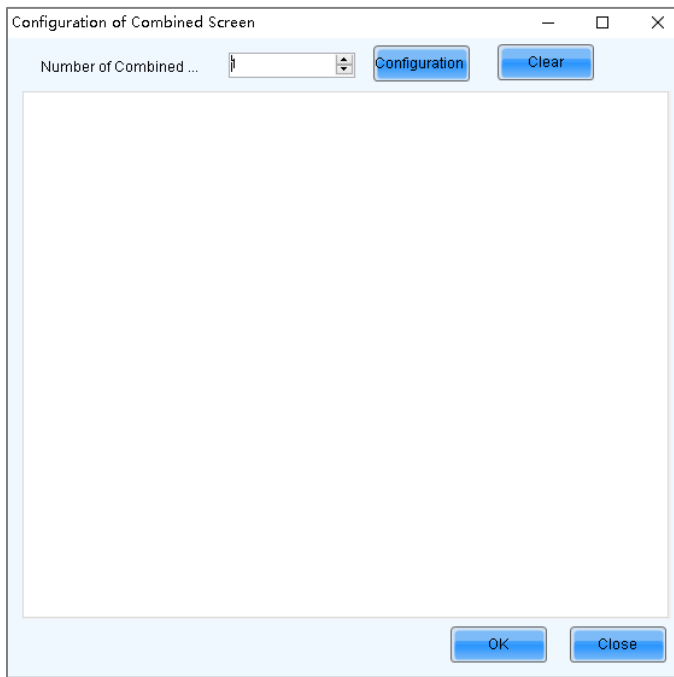

Step 3 Set the number of combined screens and click **Configuration**.

Step 4 Set the combined screen name and number of screens in the combined screen, and then click **Configuration**.

Figure 8-5 Configuration of combined screen

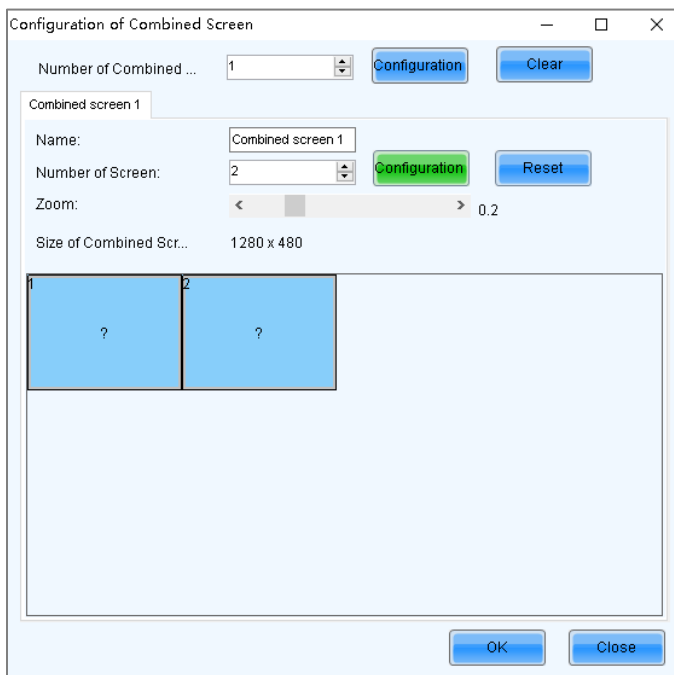

Step 5 Right click the first screen to pop up the window as shown in [Figure 8-6](#). Choose a communication port and its associated screen.

Figure 8-6 Associated screen

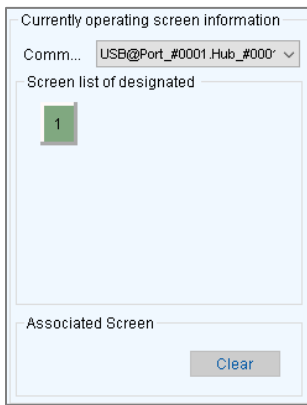

Step 6 Do the same for other screens of the combined screen.

Step 7 Drag the screen to snap it to other screens.

Figure 8-7 Adjusting screen position

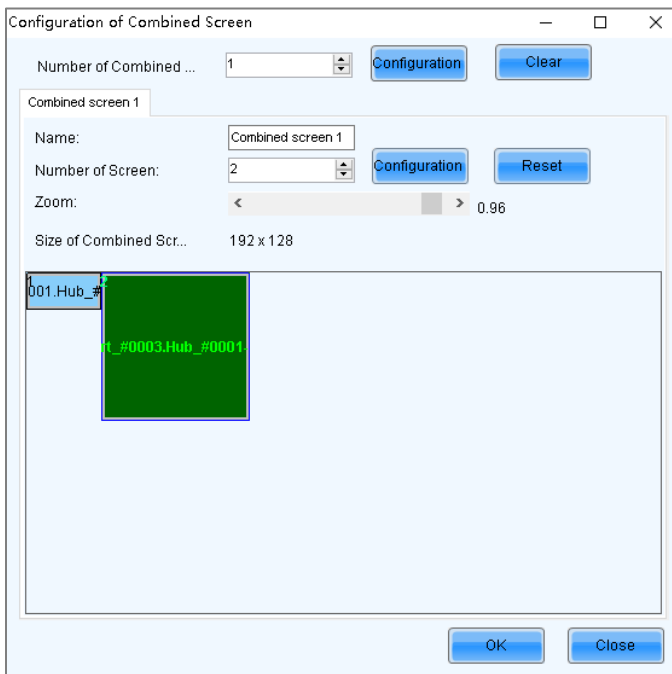

Step 8 After the settings are done, click **OK**.

8.3 Prestore Screen

Applications

Set the picture displayed on the screen during startup process, or displayed when the Ethernet cable is disconnected or there is no video signal.

Applicable Products

All receiving cards and sending cards

Prerequisites

A picture in BMP, JPG or PNG format is prepared.

Related Information

None

Operating Procedure

Step 1 On the menu bar, choose **Settings > Prestore Screen**.

Figure 8-8 Prestore picture settings

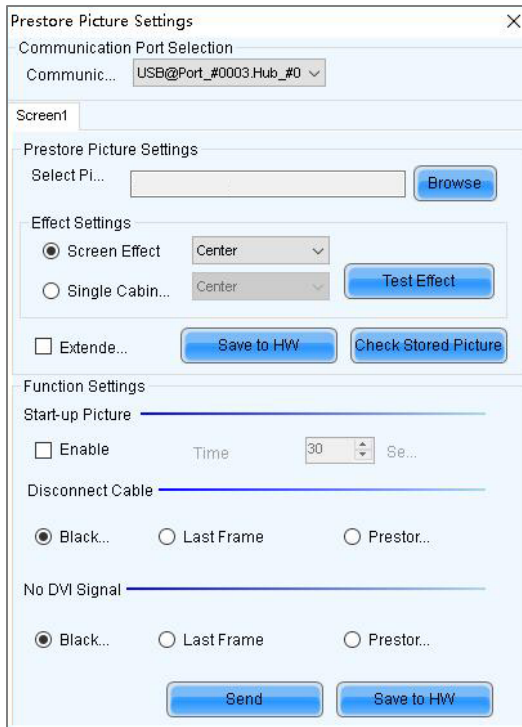

Step 2 Choose a communication port.

Step 3 Set a prestore picture.

1. Click **Browse** to select a picture.
2. Set the screen display effect and click **Test Effect** to view the actual effect.
 - Screen Effect: The selected picture will be stretched, tiled or centered to fit the screen.
 - Single Cabinet Effect: The selected picture will be stretched, tiled or centered to fit each cabinet of the screen.

Select **Extended Screen** to display the picture on the extended screen.

3. Click **Save to HW** to save the prestore picture to the hardware.
4. Click **Check Stored Picture** to view the current prestore picture.

Step 4 Set the picture displayed during startup process, or displayed when the Ethernet cable is disconnected or there is no video signal.

1. Select **Enable** in the **Start-up Picture** area and set how long the prestore picture is displayed for during the startup process.
2. Set whether the screen is black, or displays the last frame image or prestore picture when the Ethernet cable is disconnected.
3. Set whether the screen is black, or displays the last frame image or prestore picture when there is no video signal.
4. After the settings are done, click **Send** to send the configuration information to the hardware.
5. Click **Save to HW** to save the configuration information to the hardware.

8.4 Receiving Card Relay

Applications

Set the receiving card relay status to manually connect or disconnect the circuit or let the circuit automatically connect or disconnect, and reset the receiving card running time.

Applicable Products

- Setting the receiving card relay status: Applicable to the MRV350 receiving card
- Resetting the receiving card running time: Applicable to all receiving cards

Prerequisites

None

Related Information

When the relay is closed, the circuit is connected. When the relay is released, the circuit is disconnected.

The running time is accumulated as the receiving card works, and will not be reset after the receiving card is powered off.

Operating Procedure

Step 1 On the menu bar, choose **User > Advanced Synchronous System User Login**. Enter the password and click **Login**.

The default password is “admin”.

Step 2 Choose **Settings > Receiving Card Relay**.

Figure 8-9 Setting receiving card relay

Step 3 Choose a communication port and perform the following operations as required.

✦ Set receiving card relay

- Select **Disconnected** and click **Send** to disconnect the circuit.
- Select **Connected** and click **Send** to connect the circuit.
- Select **Automatic** and set the threshold temperatures for both connecting and disconnecting the relay, and then click **Send**.

✦ Reset receiving card running time

Click **Timing Resetting** to record the receiving card running time from 0.

8.5 Configuration Information Management

Applications

Import and export the NovaLCT configuration files for quick configuration in NovaLCT.

Applicable Products

N/A

Prerequisites

None

Related Information

None

Operating Procedure

Step 1 On the menu bar, choose **Settings > Configure Information Management**.

Figure 8-10 Configuration file management

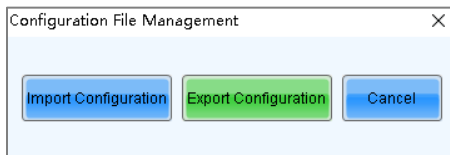

Step 2 Perform any of the following operations as required.

✦ **Import Configuration**

Click **Import Configuration**, select a file in .zip format, and then click **Open**.

✦ **Export Configuration**

Click **Export Configuration**, select the file save path and enter the file name, and then click **Save**.

8.6 Screen Control

Applications

Set the screen display status. Use the test pattern to perform the screen aging test and detect problems. Control the cabinet LCD backlight status.

Applicable Products

- Flipping: Applicable to the MCTRL660 PRO sending card
- Other functions: Applicable to all receiving cards and sending cards

Prerequisites

None

Related Information

None

Operating Procedure

Step 1 Click  or choose **Tools > Screen Control** from the menu bar.

Figure 8-11 Screen control

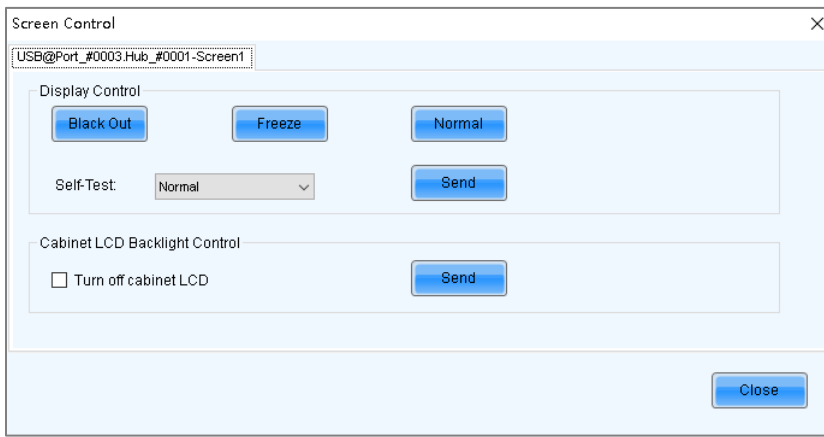

Step 2 Perform any of the following operations as required.

✦ **Set screen display**

Select **Black Out**, **Freeze** or **Normal**. When **Freeze** is selected, the screen always displays the current image.

✦ **Select test pattern**

Select a test pattern from the drop-down list and click **Send**. The receiving card will display the selected test pattern on the screen.

✦ **Set LCD backlight status**

Select or deselect **Turn off cabinet LCD** and click **Send**.

Step 3 When the MCTRL660 PRO is connected, select a flipping option for the image of the Ethernet port as shown in Figure 8-12. The options include **Disable**, **Left-Right**, or **Top-Bottom**. If other devices are connected, skip this step.

Figure 8-12 Flipping

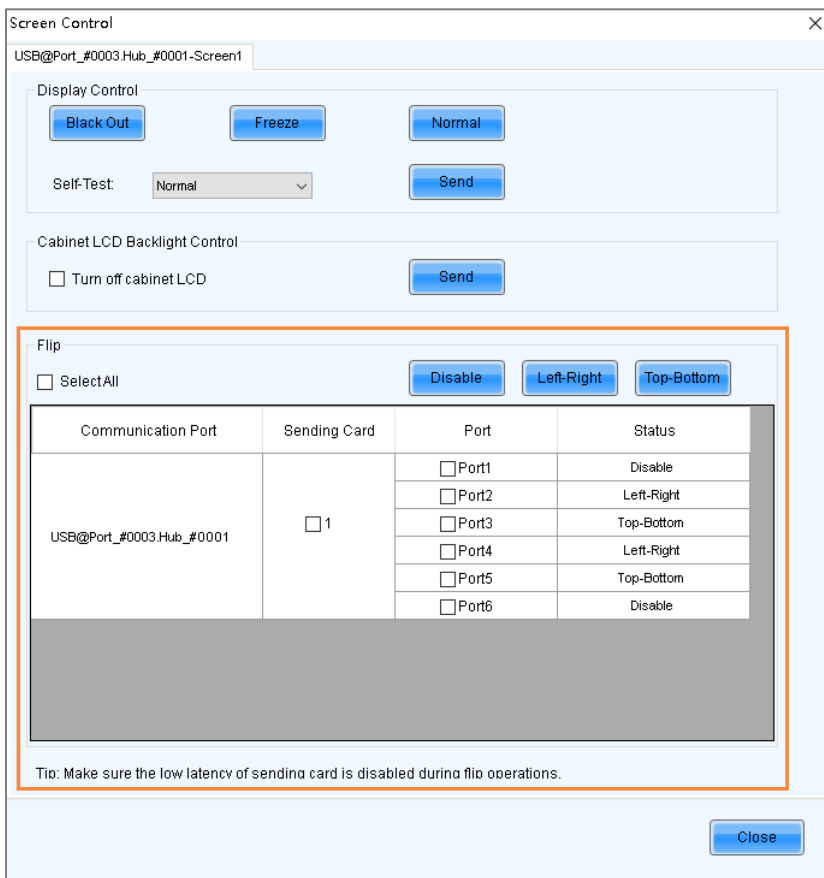

8.7 Controller Cabinet Configuration File Import

Applications

Save the receiving card configuration files to the sending card, so as to send the configuration files to the receiving card on site by using the configuration file import function of the sending card.

Applicable Products

- Importing cabinet configuration files: Applicable to the device-level sending cards
- Renaming device: Applicable to the NovaPro HD, VX2, VX4, VX4S, VX5s, VX6s, K4, K4S, K6s, VD43, VX2U, VX4U, K4U, K2U, VX2S, CVT4K-S, MCTRL4K, K16, H9, V1260, NovaPro UHD Jr, MCTRL1600, MCTRL R5, MCTRL660 PRO and E8000

Prerequisites

The receiving card configuration files in .rcfgx or .rcfg format are ready. The cabinet must be a regular cabinet, and cannot be in triple or quadruple strip output mode.

Related Information

None

Operating Procedure

Step 1 On the menu bar, choose **Tools > Controller Cabinet Configuration File Import**.

Figure 8-13 Importing cabinet configuration files

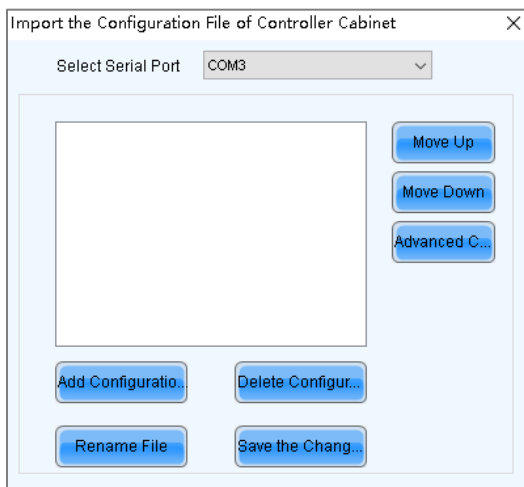

Step 2 Choose a communication port.

Step 3 Click **Add Configuration File**, select a configuration file, and click **Open**.

You can add configuration files for multiple receiving cards as needed. You can also delete and rename the configuration file.

Step 4 If you need to specify one or multiple sending cards, click **Advanced Configuration**. Select the desired sending cards in the displayed dialog box, and click **OK**. If you want to save the configuration files to all the connected sending cards, skip this step.

Figure 8-14 Advanced configuration



- Step 5 After the settings are done, click **Save the Change to HW** to save the configuration files to the sending cards.
- Step 6 After the files are saved successfully, click **OK**.
- Step 7 If the renaming function is supported by device, you can rename the sending card as shown in [Figure 8-15](#). If not supported, skip this step.

Figure 8-15 Renaming sending cards

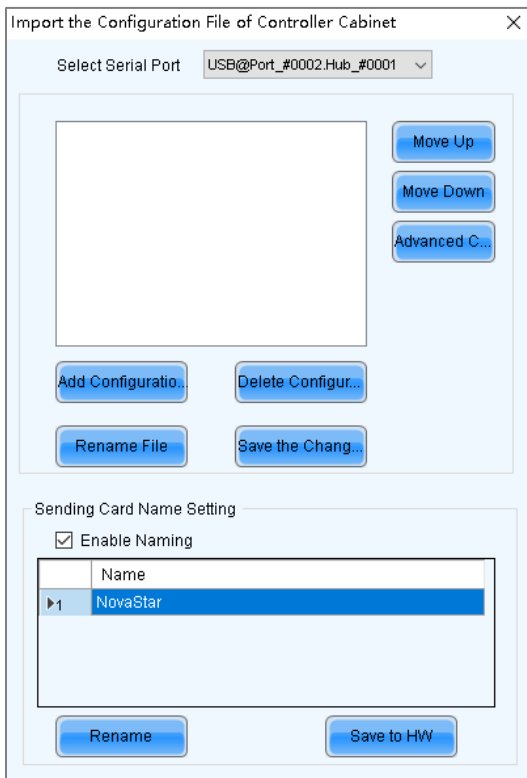

1. Select **Enable Naming**.
2. Choose a sending card and click **Rename**.
3. Enter the new name that contains only letters, and click **OK**.
4. Click **Save to HW**.

8.8 Video Control

Applications

Select an input source type for the video controller, and set the input, output and stitching.

Applicable Products

The NovaPro HD video controller

Prerequisites

None

Related Information

None

Operating Procedure

Step 1 On the menu bar, choose **Tools > Video Control**.

Figure 8-16 Video control

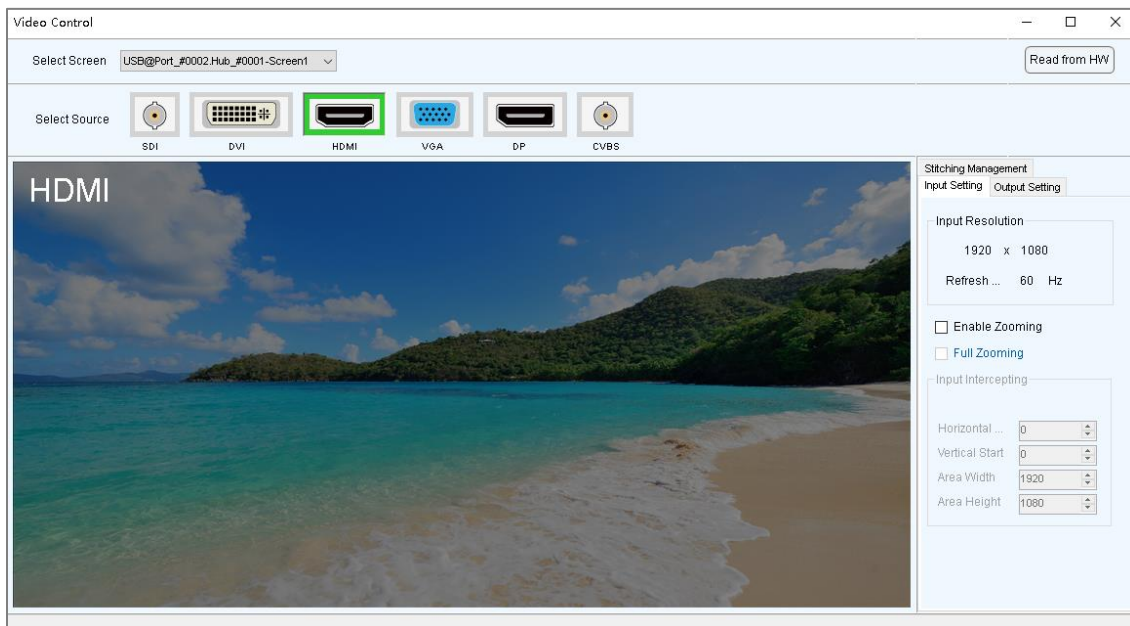

Step 2 Choose a screen.

Step 3 Click an icon to select an input source.

Step 4 Perform any of the following operations as required to set the video control related parameters.

+ Set input and output

- Disable zooming

You can set only the position of the output window.

- Enable zooming

Select **Enable Zooming** to set the input intercepting position and size, as well as the output window position and size.

The output window size must be smaller than or equal to the LED screen size.

- Full zooming

Select **Enable Zooming** and **Full Zooming**. Output parameter settings are not required.

The output image will be adjusted to the same size as the LED screen after this function is enabled.

+ Set stitching

- Select **Enable Stitching** to set the total number of pixels of the LED screen.
- Set the position and size of the area loaded by current device, and then set the output window position and size. If you want to display the image in pixel-to-pixel mode, please click **Pixel-to-pixel Auto Set**.
- Set the positions and sizes of the areas loaded by other devices, and then set the output window positions and sizes.

The total size of the areas loaded by all devices must be the same as the total pixel number of the screen.

Figure 8-17 Stitching management



8.9 Module ID Settings

Applications

Set ID for the module containing a flash memory.

Applicable Products

The receiving cards that support module Flash or smart module

Prerequisites

The Flash arrangement is completed as described in [5.7 Set Audio Input](#)

Applications

Set the audio input to HDMI or external audio.

Applicable Products

The sending card MCTRL2000

Prerequisites

None

Related Information

None

Operating Procedure

- Step 1 On the menu bar, choose **User > Advanced Synchronous System User Login**. Enter the password and click **OK**.
The default password is “admin”.

- Step 2 Click  or choose **Settings > Screen Configuration** from the menu bar to open the dialog box shown in [Figure 5-47](#).

Figure 8-18 Screen configuration method

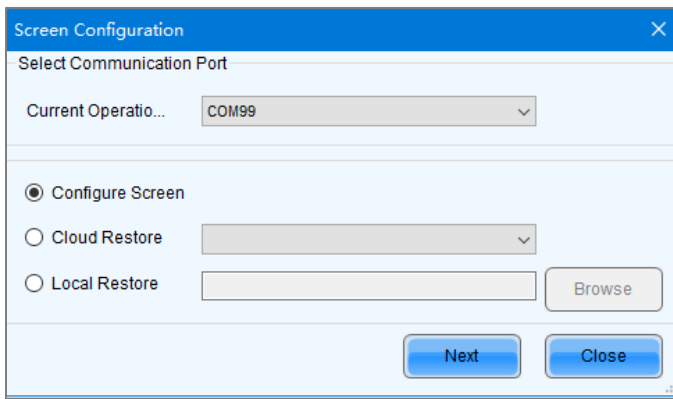

Step 3 Choose a communication port.

Step 4 Select **Configure Screen** and click **Next**.

Step 5 Select the **Sending Card** tab.

Step 6 Select **HDMI** or **External Audio** from the drop-down list and then click **Send**.

Figure 8-19 Audio input

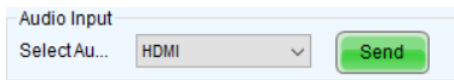

Set Performance Parameters.

Related Information

Some modules do not support ID settings. For details, please contact NovaStar.

Operating Procedure

Step 1 On the menu bar, choose **User > Advanced Synchronous System User Login**. Enter the password and click **Login**.

The default password is “admin”.

Step 2 Choose **Tools > Module ID setting**.

Step 3 Click **Refresh** to view the module IDs.

Figure 8-20 Viewing module IDs

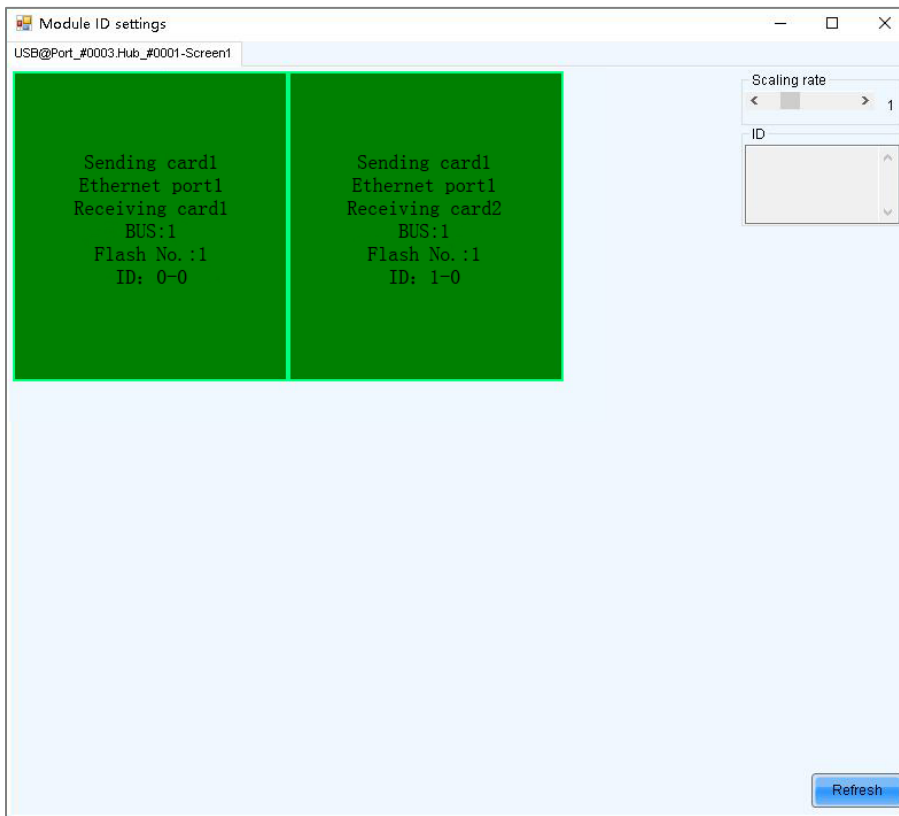

Step 4 Type "admin" to access the ID setting pane.

Figure 8-21 Setting module ID (regular screen)



Figure 8-22 Setting module ID (complex screen)

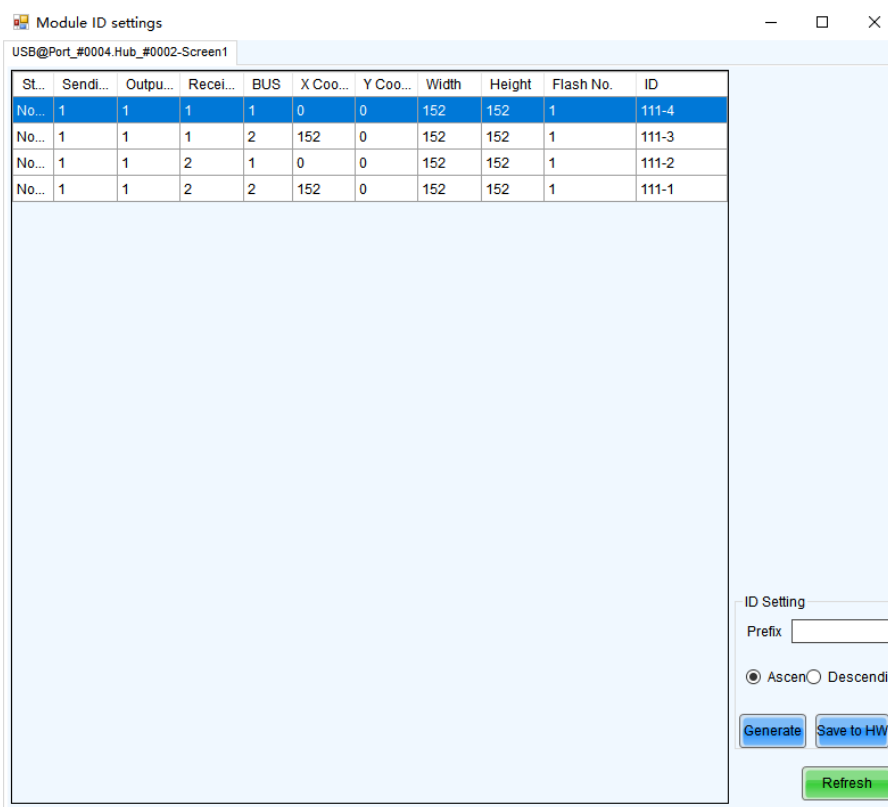

Step 5 Select the ID generation method and then click **Generate** to set IDs for all the modules. When manually setting the ID, for regular screens, double click a single module and set its ID in the displayed dialog box, and then click **OK**; for complex screens, double-click the cell of ID column, set the ID and click any other place of the interface.

- Prefix: Set the prefix of the module ID.
- Sort: Select the sorting type for the module IDs.
 - Z-shape: Generate module IDs from left to right for all the rows from top to bottom. The ID format is “*receiving card number-module number*”.
 - N-shape: Generate module IDs from bottom to top for all the columns from left to right. The ID format is “*receiving card number-module number*”.
 - Inverse Z-shape: Generate module IDs from right to left for all the rows from top to bottom. The ID format is “*receiving card number-module number*”.
 - Inverse N-shape: Generate module IDs from top to bottom for all the columns from left to right. The ID format is “*receiving card number-module number*”.
 - No.: The ID format is “*receiving card number-Flash number*”.
 - Ascending: The module IDs are in ascending order.
 - Descending: The module IDs are in descending order.
- By cabinet: Generate the IDs for all modules based on cabinets by Z type or N type, or number the modules by “*sending card number-output port number-receiving card number-Flash number*”.

Step 6 After the settings are done, click **Save to HW** to save the configuration information to the hardware.

8.10 Sending Card Relay Settings

Applications

Set the status of the sending card relay to turn on or off the power of the receiving card.

Applicable Products

The KT8 sending card

Prerequisites

None

Related Information

When the relay is closed, the circuit is connected. When the relay is released, the circuit is disconnected.

Operating Procedure

Step 1 On the menu bar, choose **User > Advanced Synchronous System User Login**. Enter the password and click **Login**.

The default password is "admin".

Step 2 Choose **Tools > More > Sending Card Relay**.

Figure 8-23 Sending card relay

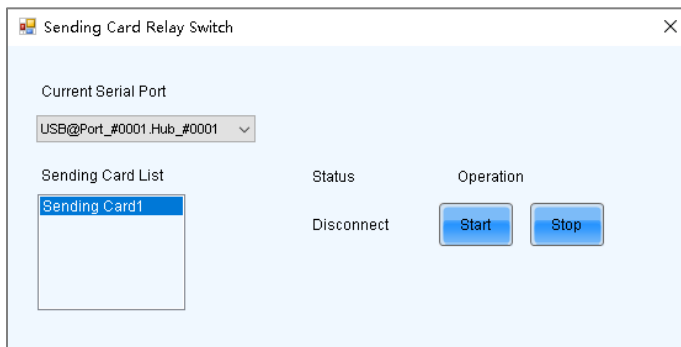

Step 3 Choose a communication port and a sending card.

Note: When the sending cards are cascaded, multiple sending cards are displayed in the list.

Step 4 Check the relay status and perform the following operations as required.

- Click **Start** to connect the circuit.
- Click **Stop** to disconnect the circuit.

8.11 Optical Port Settings

Applications

When automatic pairing between two CVT10 devices fails, set the optical ports of those devices respectively to make pairing succeed.

Applicable Products

The CVT10 fiber converter

Prerequisites

None

Related Information

When the sending card has no optical ports, two CVT10 devices must be used for photoelectric conversion. The two CVT10 devices can pair automatically. After successful pairing, they can transmit data normally.

Figure 8-24 Photoelectric conversion between two CVT10 devices

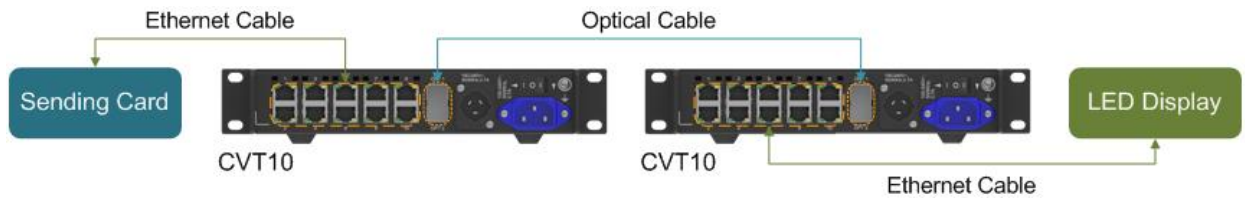

Operating Procedure

Step 1 On the menu bar, choose **User > Advanced Synchronous System User Login**. Enter the password and click **Login**.

The default password is “admin”.

Step 2 Choose **Tools > More > Optical Port Settings**.

Figure 8-25 Optical port settings

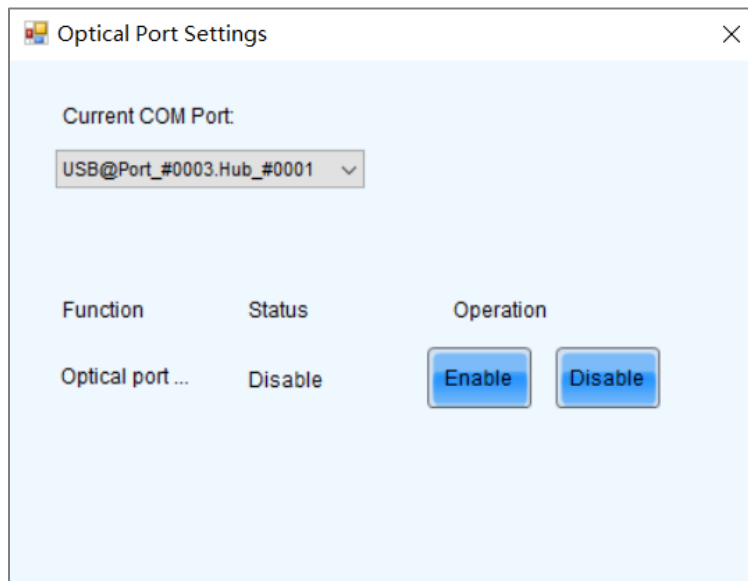

Step 3 Choose a communication port.

Step 4 Click **Enable**.

9 Screen Maintenance

9.1 Firmware Program Update

Applications

Check the current firmware program version of the receiving card and sending card, and update the program.

Applicable Products

All receiving cards and sending cards

Prerequisites

The program update package is prepared.

Related Information

None

Operating Procedure

Step 1 On the menu bar, choose **User > Advanced Synchronous System User Login**. Enter the password and click **Login**.

The default password is “admin”.

Step 2 Type “admin” to open the program loading window as shown in [Figure 9-1](#).

Figure 9-1 Program loading

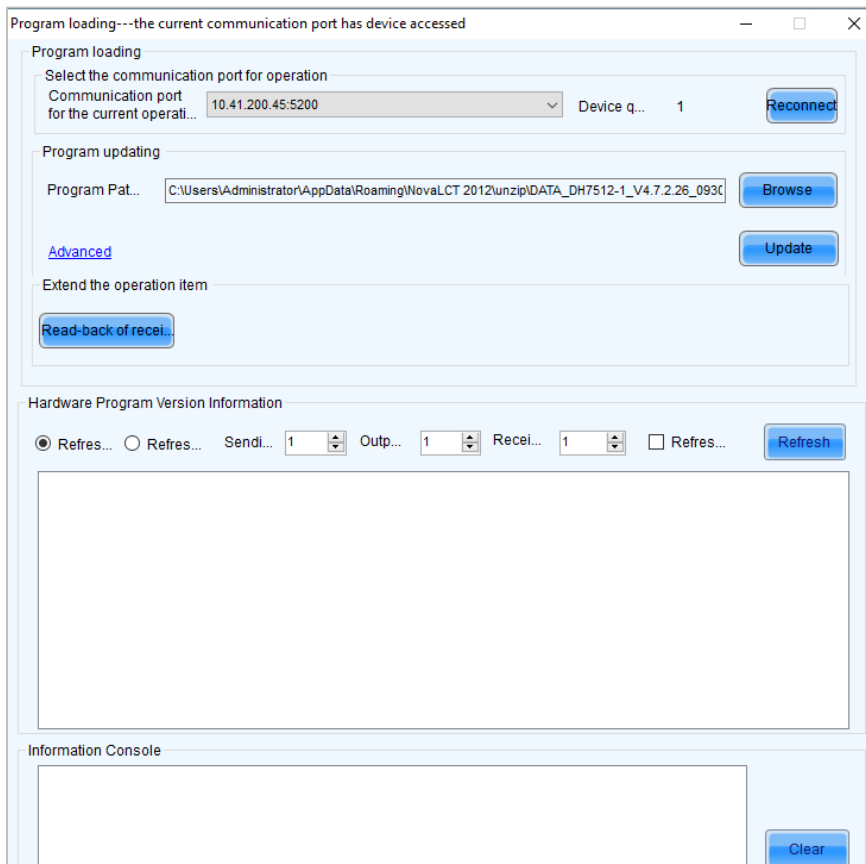

Step 3 Choose a communication port.

If you need to reconnect the sending card, click **Reconnect**.

Step 4 Specify the viewing range and click **Refresh** to view the current program version of the hardware.

- Refresh All: View the program versions of all the sending cards and receiving cards.
- Refresh Specified: View the program versions of the specified sending cards and receiving cards.

If the module has an MCU, select **Refresh Module MCU** to view the MCU version.

Figure 9-2 Viewing program version

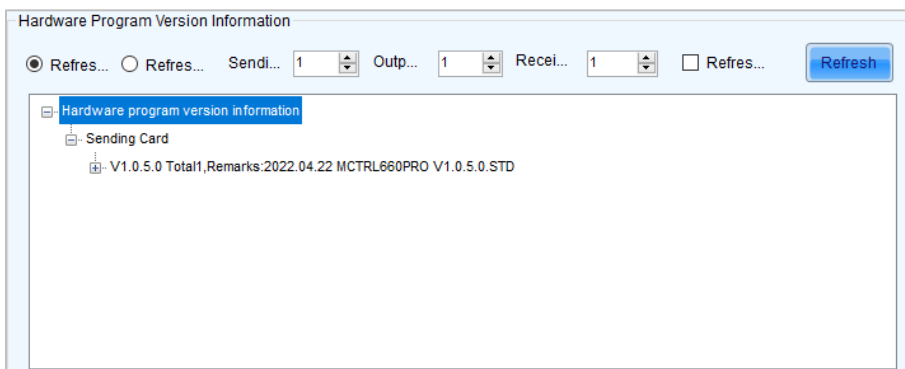

Step 5 Click **Browse**, select a program package, and click **OK**.

Step 6 Click **Advanced**, select the items to be updated, and click **OK**.

Step 7 Click **Update**.

Step 8 Set to update the programs of all receiving cards or the specified receiving card, and then click **OK**.

Figure 9-3 Selecting send mode

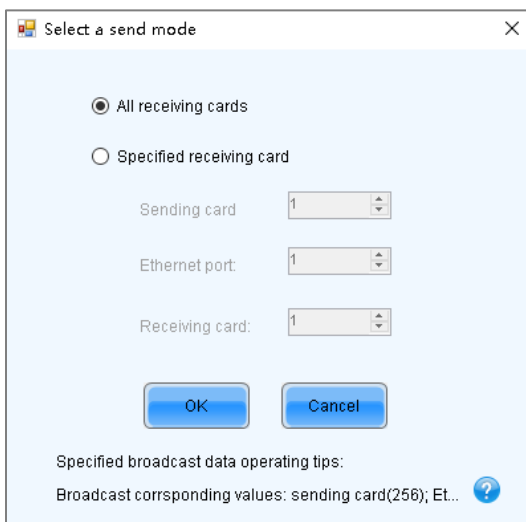

Step 9 After the programs are updated successfully, click **OK**.

Note

If the receiving card supports program readback, click **Read-back of receiving card program** to save the receiving card program to a specified location.

9.2 LED Error Detection

Applications

Detect the damaged LED lights and locate them on the screen.

Applicable Products

- Use monitoring card for Led error detection: Applicable to the MRV320 and MRV560 receiving cards

- Use smart module for Led error detection: Applicable to the A4, A4s, A5, A5s, A5s Plus, A7, A7s, A7s Plus, A8, A8s, A9s, A10s Plus, XC200, XC100 and B4s receiving cards. The smart module Led error detection function is a customized function of the receiving cards.

Prerequisites

- The module driver chip must be support LED error detection.
- If you want to use the Led error detection function of the monitoring card, the module driver chip must support 1/16 scan or below, and the MON300 monitoring card is required between the connection of module and the MRV320 or MRV560.

Related Information

None

Operating Procedure

Step 1 On the menu bar, choose **Tools > Led Error Detection**.

Figure 9-4 Led error detection

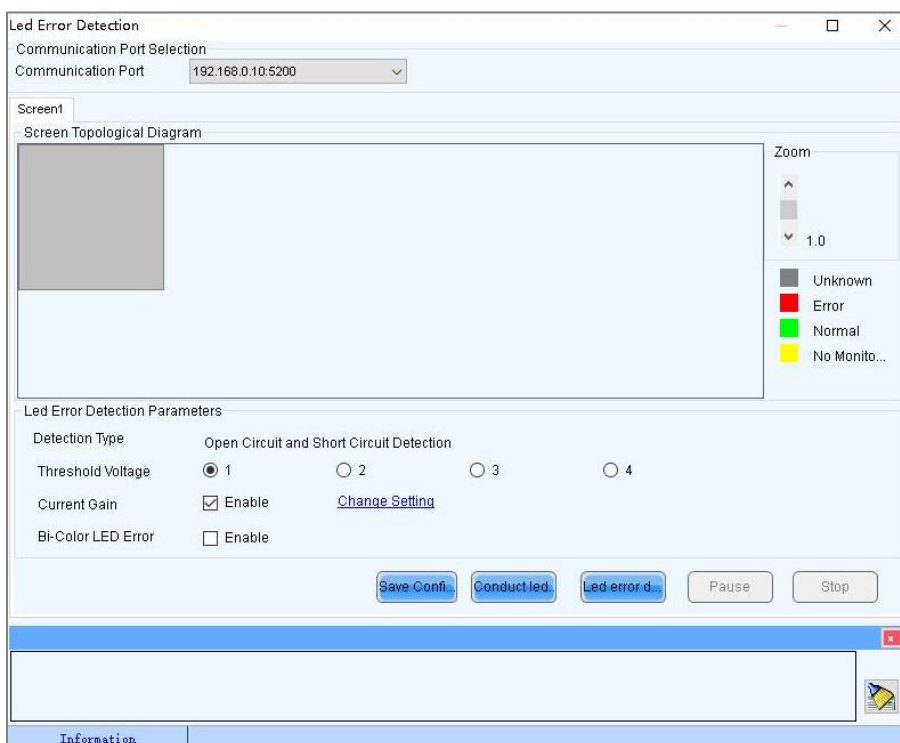

Step 2 Choose a communication port.

Step 3 Set Led error detection parameters.

- Detection Type: The detection types supported by the driver chip
- Threshold Voltage: The threshold voltage of the driver chip, which can be set based on the information provided by the screen manufacturer
- Current Gain: Select whether to enable the current gain function. Click **Change Setting** to adjust the current gain.
- Bi-Color LED Error: Select whether to detect only the red and green LED lights.

Step 4 Click **Conduct led error detection for full screen**, or select a cabinet on the screen topological diagram and click **Led error detection selection**.

Step 5 After the detection is done, click **OK**.

Figure 9-5 Result of the Led error detection for the whole screen

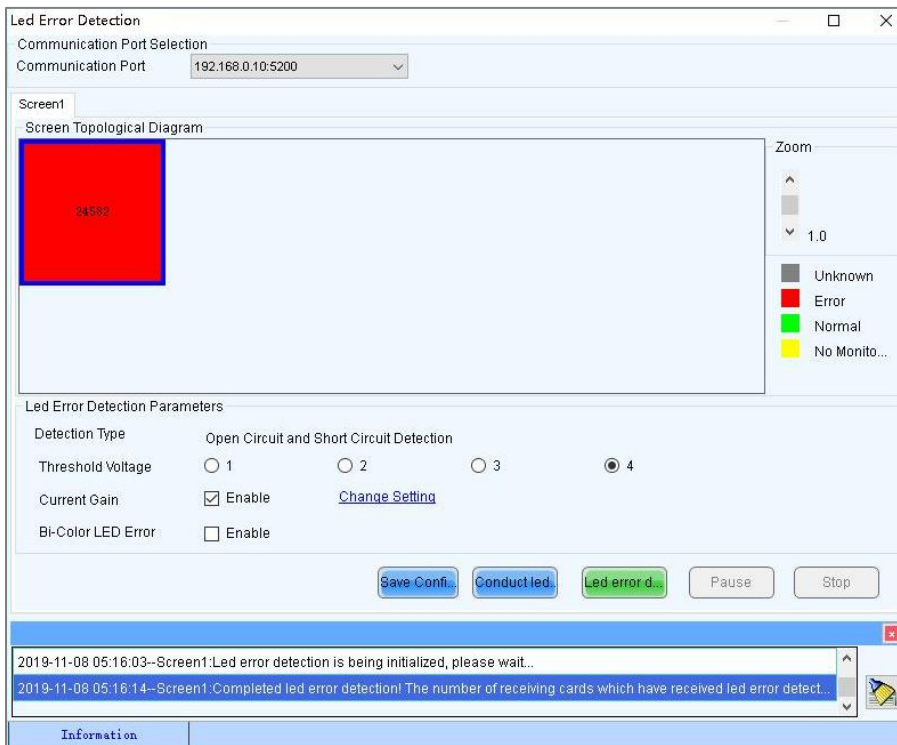

The number displayed on the topological diagram indicates the number of the faulty LED lights. Hover the mouse over the topological diagram to view the detailed Led error detection information.

Step 6 Double click a cabinet in the topological diagram to access the interface shown in Figure 9-6.

Figure 9-6 Result of the Led error detection for all the modules



Step 7 Select a red module, and select **Red A**, **Green**, **Blue** or **Red B** (virtual red) on the right to view the faulty LED lights which are shown in black.

9.3 Reset Run Time

Applications

Reset the receiving card run time displayed on each cabinet LCD.

Applicable Products

All receiving cards

Prerequisites

None

Related Information

The run time is stored in the receiving card and displayed on the cabinet LCD.

Operating Procedure

Step 1 On the menu bar, choose **Tools > More > Reset Run Time**.

Figure 9-7 Resetting run time



Step 2 Choose a communication port and a screen.

Step 3 Click **Reset**.

9.4 Bit Error Detection

Applications

Test whether the communication of the receiving card Ethernet port is normal.

Applicable Products

All receiving cards

Prerequisites

None

Related Information

None

Operating Procedure

Step 1 On the menu bar, choose **Tools > More > Bit Error Detection**.

Step 2 Click **Manually** as shown in [Figure 9-8](#).

Figure 9-8 Bit error detection

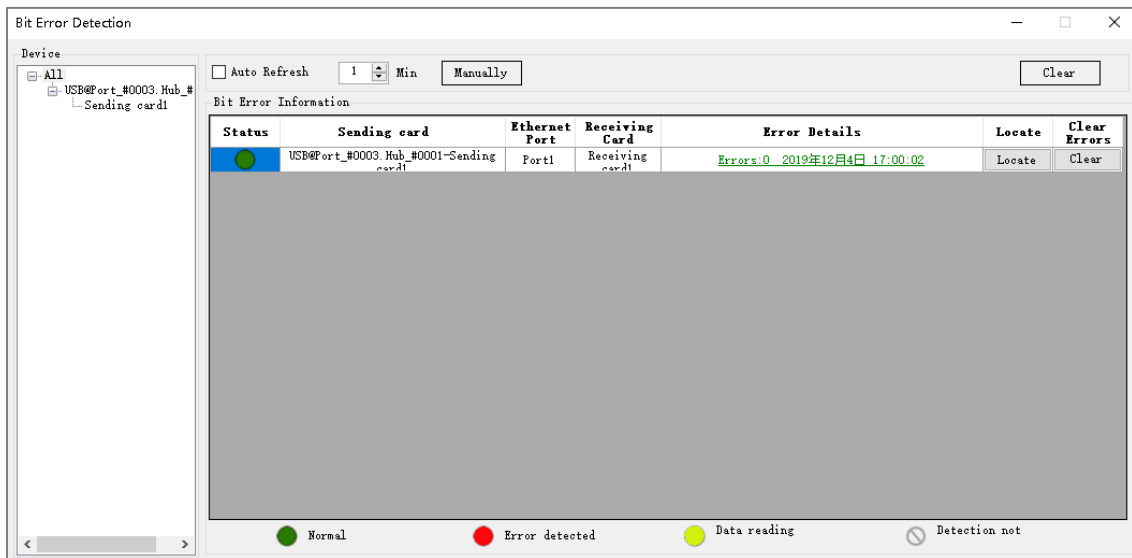

Step 3 If the communication is abnormal, perform any of the following operations as required. If the communication is normal, skip this step.

✦ View error details

Click the link in the **Error Details** column and view the detailed error information in the displayed dialog box.

✦ Locate display area

Click **Locate** to view the display area on the screen.

✦ Clear errors

Click **Clear Errors** to reset the error quantity to 0.

Step 4 (Optional) Select **Auto Refresh** and set the refreshing period.

9.5 View Hardware Information

Applications

Set the current time of the hardware, and view the sending card SNs and hardware program version information.

Applicable Products

All receiving cards and sending cards

Prerequisites

None

Related Information

Currently only hour, minute and second can be set, but the date cannot be set.

Operating Procedure

Step 1 On the menu bar, choose **Settings > Hardware Information**.

Figure 9-9 Hardware information

The screenshot shows the 'Hardware Information' window with the following sections:

- Time:** Current Time of Hardware: 12/04/2019 17:02:42. Buttons: Read, Set.
- Select the Communication Port:** Current Operation C...: USB@Port_#0003.Hub_#0001.
- SN Number of Sending Card:** A table with columns 'Serial Number' and 'SN Number'. The first row shows Serial Number '1' and SN Number '1205-1C00-8002-0000 (18-5-28-0-640)'. A 'Reread' button is below the table.
- Hardware Program Version Information:** Radio buttons for 'Refres...' (selected) and 'Refres...'. Spinners for 'Sendi...' (1), 'Outp...' (1), and 'Recei...' (1). A 'Refresh' button.
- Information Console:** A text area for logs and a 'Clear' button.

Step 2 Choose a communication port.

After a communication port is selected, the current hardware time will be refreshed automatically. You can also click **Read** to manually update the hardware time.

Step 3 If you want to set the current time of the sending card to that of the computer, click **Set**; otherwise, skip this step.

Step 4 Click **Reread** to view the sending card SNs.

Step 5 Specify the refreshing range, and click **Refresh** to view the current program version of the hardware.

- Refresh All: View the program versions of all sending cards and receiving cards.
- Refresh Specified: View the program versions of the specified sending cards and receiving cards.

If the module has an MCU, select **Refresh Module MCU** to view the MCU version.

Figure 9-10 Viewing program version

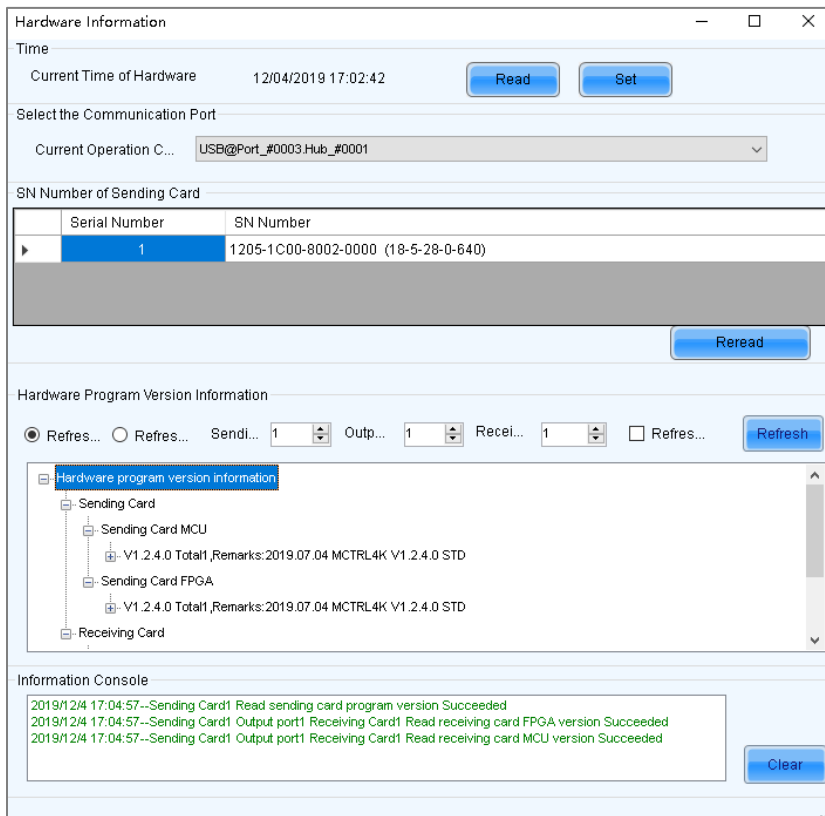

9.6 Send NCP Files

Applications

Send the NCP file exported from the Cabinet Tool software to the receiving card to update its firmware program and configuration parameters.

Applicable Products

All receiving cards

Prerequisites

The NCP file (.ncp) is prepared and the applicable models in the file matches the currently used receiving card.

Related Information

None

Operating Procedure

Step 1 Choose **Tools** > **Send NCP** from the menu bar.

Figure 9-11 Selecting the communication port

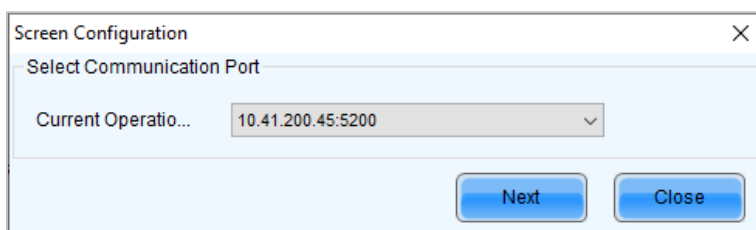

Step 2 Select a communication port and click **Next**.

- Step 3 On the Manage NCP dialog box, go to the **Send NCP** tab and configure the data transmission method according to the descriptions below.
- Send by topology
Select a screen and then select **Full Screen**. You can also select the target cabinets and choose **Select by Ethernet port** or **Select by cabinet**.
 - Send by physical addresses
Double-click on the cell and enter the sending card number, Ethernet port number, and receiving card number.

Figure 9-12 Send NCP

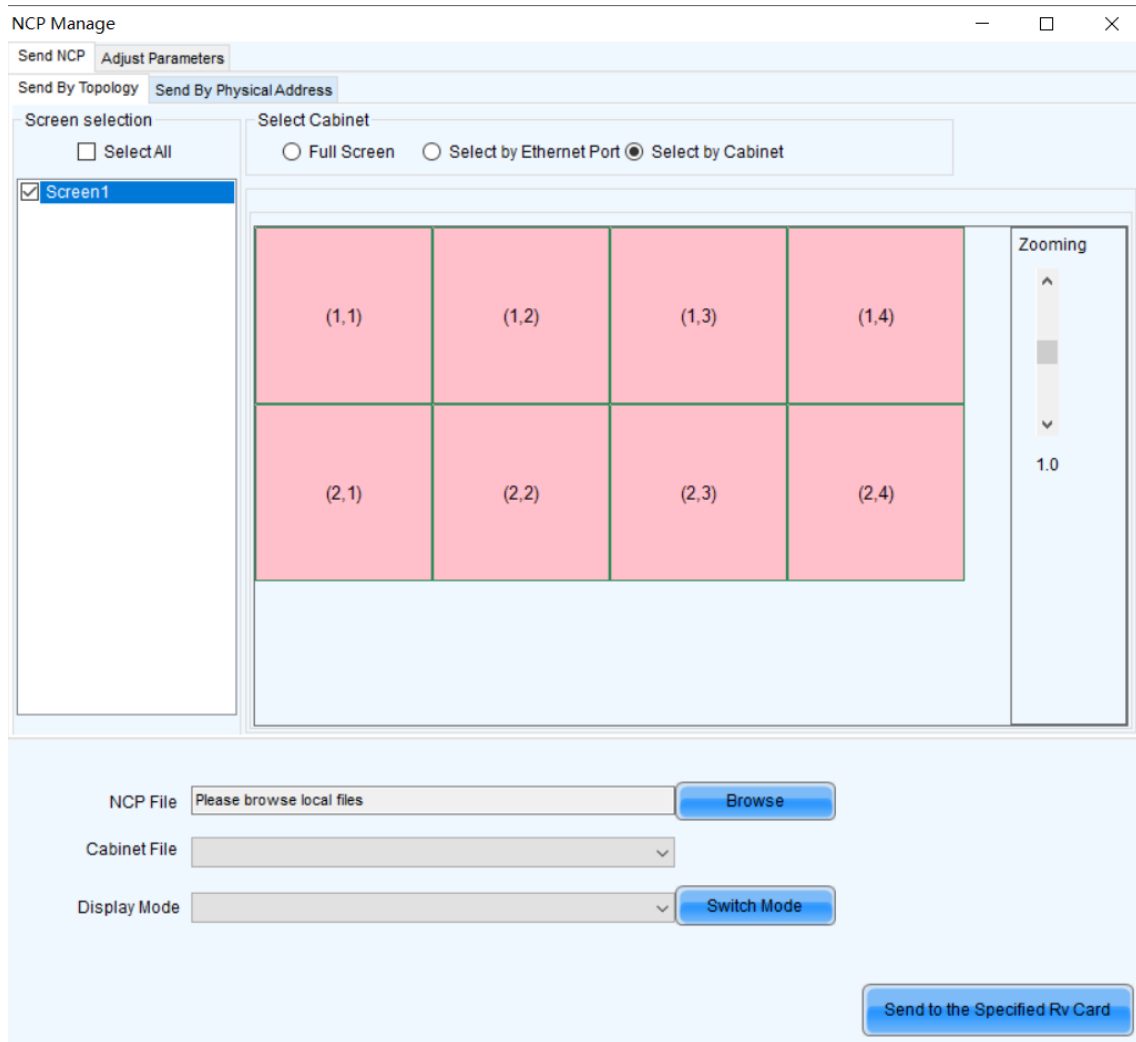

- Step 4 In the displayed dialog box, select an NCP file and click **Open**.
- Step 5 Select a cabinet file and display mode.
- Step 6 Click **Switch Mode** if you only need to send configurations included in the display mode. If you also need to send firmware program and other parameters, please continue with the following steps.
- Step 7 Go to the **Adjust Parameters** tab and adjust the parameter values as needed.
- The **Rv card indicator** is used to set the operating indicator (green light).

Figure 9-13 Adjust parameters

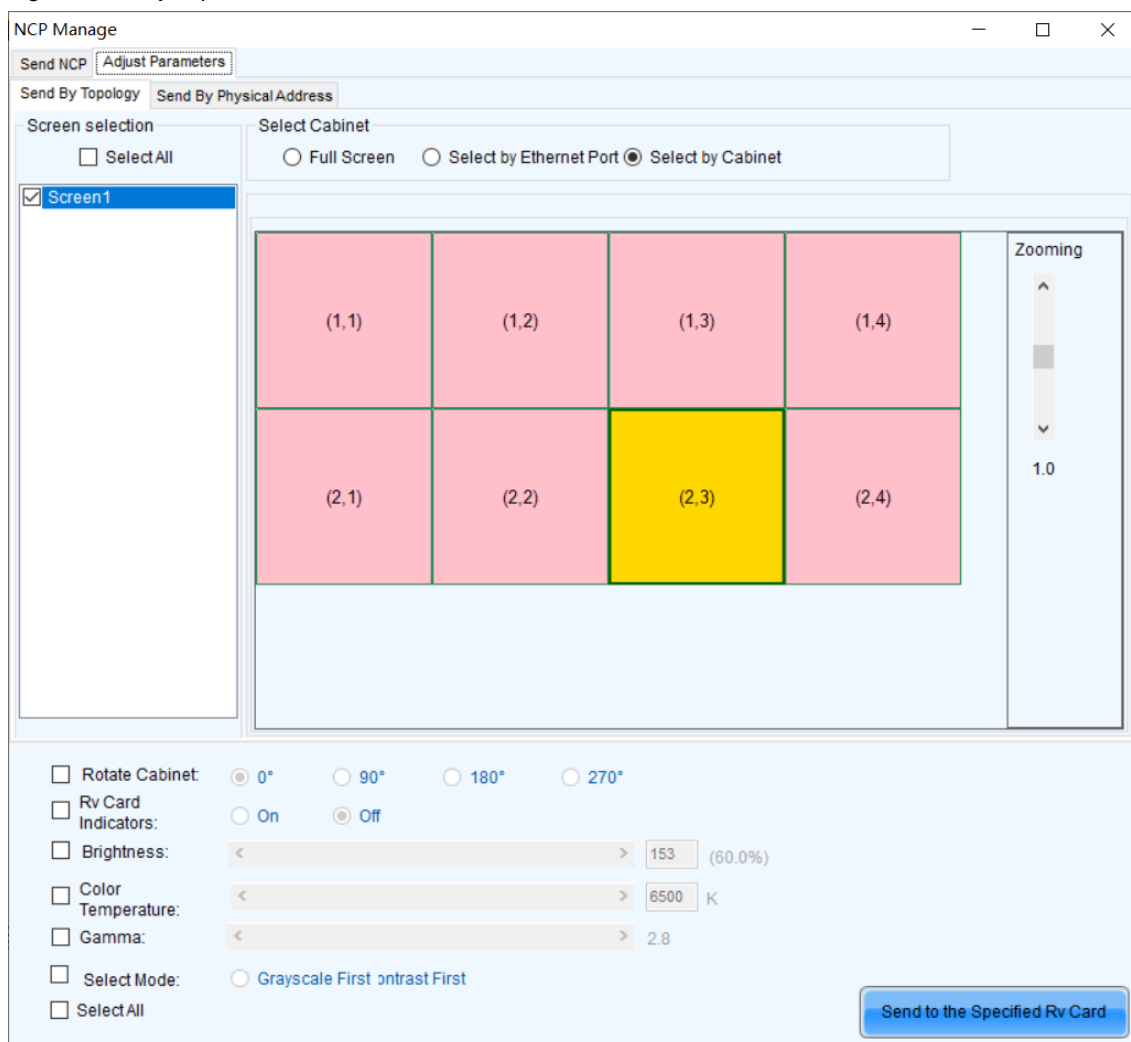

Step 8 Click **Send to Specified Rv Card** once you are done to send the firmware program and configurations to the receiving cards.

9.7 Set Cabinet Dehumidification

Applications

Dehumidify the cabinet that has been stored for a prolonged period or left unpowered for an extended duration.

Applicable Products

All receiving cards and the sending card MCTRL4K

Prerequisites

None

Related Information

None

Operating Procedure

Step 1 On the menu bar, choose **User > Advanced Synchronous System User Login**. Enter the password and click **Login**.

The default password is “admin”.

Step 2 Select **Settings > Cabinet Dehumidification**.

Step 3 Select a communication port and click **Next**.

Figure 9-14 Select the communication port

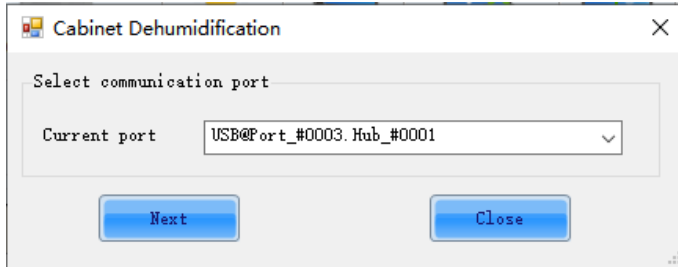

Step 4 Toggle on the Cabinet Dehumidification switch (🟢)

Figure 9-15 Cabinet dehumidification

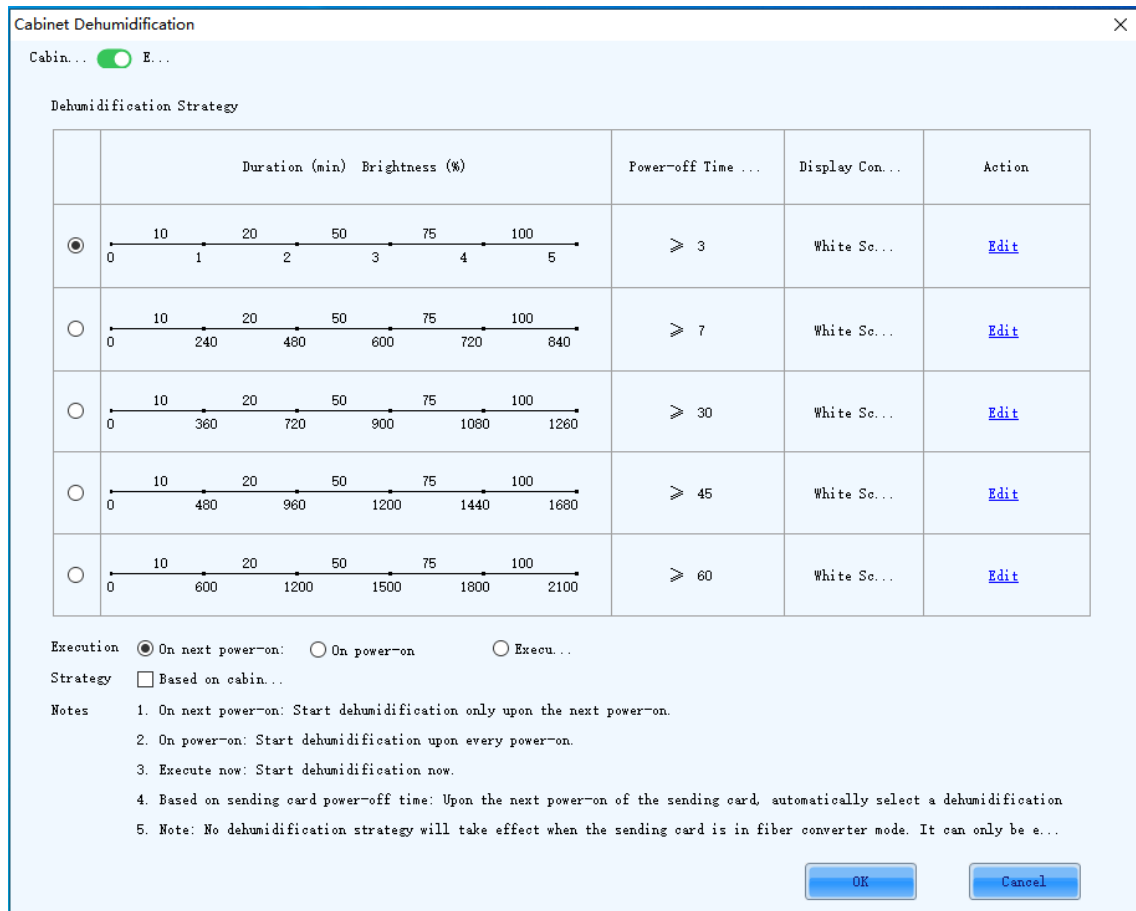

Step 5 Click **Edit**. In the pop-up dialog box, set the dehumidification strategy and click **OK**.

Figure 9-16 Set dehumidification strategy

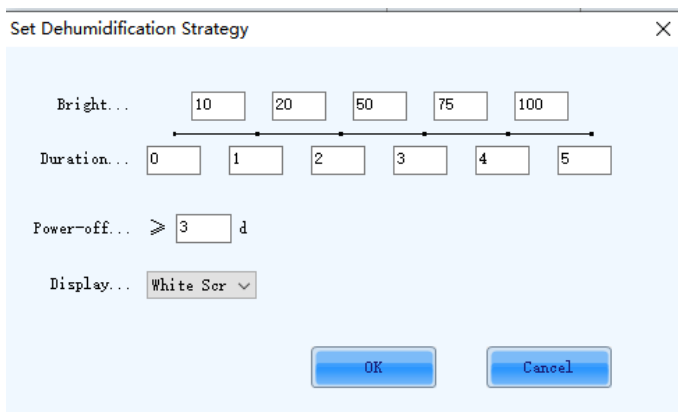

- **Brightness:** The corresponding screen brightness when the dehumidification duration reaches a certain range.
- **Duration:** Duration for dehumidification.
- **Power-off Time:** The duration of the sending card power-off time.
- **Display Content:** The displayed content on the screen during the dehumidification.
 - **White Screen:** Display a white screen.
 - **From Input:** Display the current video source.

Step 6 Select a dehumidification strategy and then select an execution mode.

- **On next power-on:** If **Based on sending card power-off time** is not selected, the screen will enter the dehumidification mode upon the next power-on, based on the user-selected strategy. If **Based on sending card power-off time** is selected, the screen will automatically match the dehumidification strategy based on the duration of the sending card power-off time, and enter the dehumidification mode upon the next power-on.
- **On power-on:** If **Based on sending card power-off time** is not selected, the screen will enter the dehumidification mode upon each power-on, based on the user-selected strategy. If **Based on sending card power-off time** is selected, the screen will automatically match the dehumidification strategy based on the duration of the sending card power-off time, and enter the dehumidification mode upon each power-on.
- **Execute now:** Start dehumidification now.

Step 7 Click **OK** once you are done.

10 Plug-in

10.1 Test Tool



Click  or choose **Plug-in > Test Tool** from the menu bar to open the Test Tool.

For more detailed instructions, please refer to *Test Tool User Manual*.

10.2 Calculator

Applications

Open the Windows calculator for users to do the necessary calculations.

Applicable Products

N/A

Prerequisites

None

Related Information

None

Operating Procedure

On the menu bar, choose **Plug-in > Calculator** to open the Windows calculator.

10.3 External Program

Applications

Add the shortcut icons for the commonly-used programs to NovaLCT user interface.

Applicable Products

N/A

Prerequisites

None

Related Information

None

Operating Procedure

Step 1 On the menu bar, choose **Plug-in > External Program**.

Figure 10-1 External program

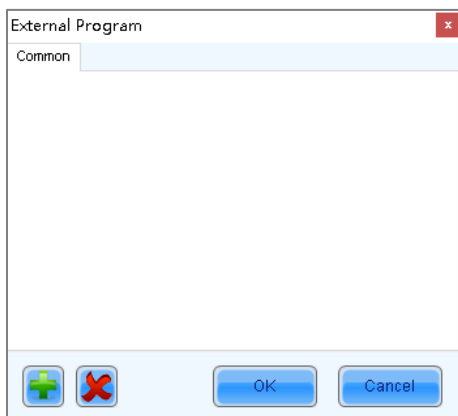

Step 2 Click .

Figure 10-2 Adding external programs

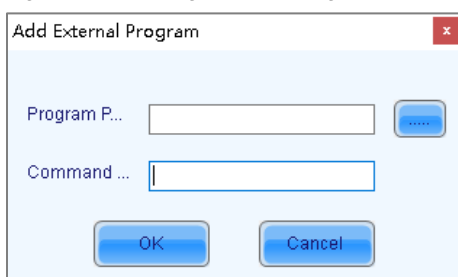

Step 3 Select the program path and enter the command line parameter as required, and then click **OK**.

If the external program is successfully added, the shortcut icon of the program will be displayed in [Figure 10-1](#).

Notes

Select an external program icon and click  to remove the program.

Step 4 Click **OK**.

11 Software Settings

11.1 Configure the Save Function

Applications

Configure the Save function that is in the **Screen Configuration** dialog box.

Applicable Products

All receiving cards and sending cards

Prerequisites

None

Related Information

None

Operating Procedure

- Step 1 On the menu bar, choose **Settings > Screen Configuration Backup Settings**.
- Step 2 Select an option and click **Save**.

Figure 11-1 Save to HW configuration

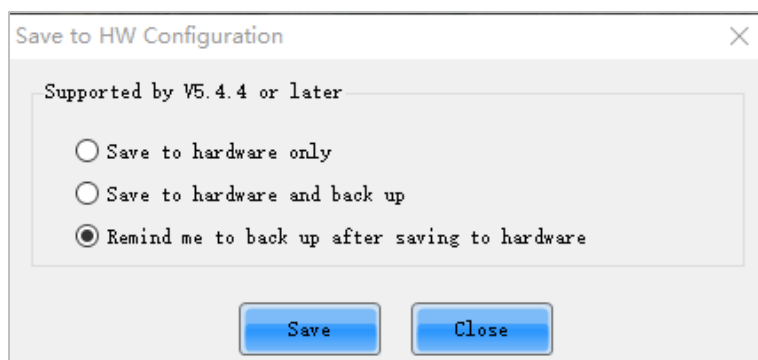

11.2 Cloud Server Configuration

Applications

Configure the cloud server address to VNNOX Care or a custom domain name. The custom domain can only be used to restore the configuration file from the cloud when setting up the screen and does not support other cloud-based functions.

Applicable Products

All receiving cards and sending cards.

Prerequisites

To configure the server address as a custom domain name, you need to have an available domain.

Related Information

None

Operating Procedure

Step 1 On the menu bar, choose **Settings > Server Configuration**.

Figure 11-2 Server configuration

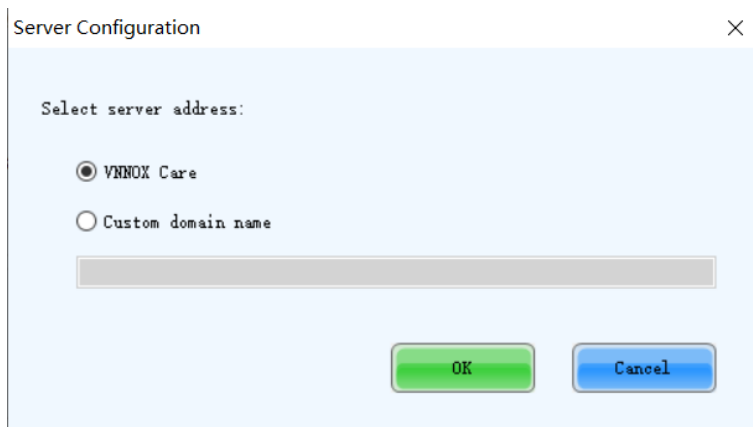

Step 2 Select **VNNOX Care** or select **Custom domain name** and enter you domain name.

Step 3 Click **OK** once you are done.

Step 4 Restart the NovaLCT for the change to take effect.

11.3 Set Main Window Starting Position

Applications

Set the coordinates of the top-left corner of the main window of NovaLCT on the desktop, and make the window display in the specified position when the software is started.

Applicable Products

N/A

Prerequisites

None

Related Information

None

Operating Procedure

Step 1 On the menu bar, choose **Settings > The Main Window Starting Position**.

Figure 11-3 Setting starting position coordinates

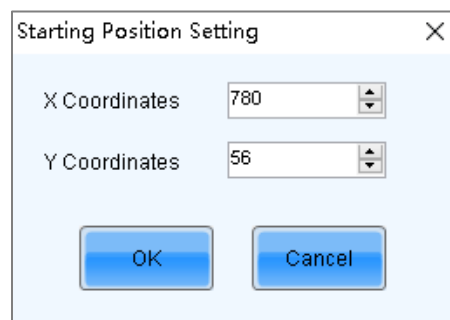

Step 2 Set the coordinates of the top-left corner of the main window on the desktop, and click **OK**.

After the settings are done, the main window moves to the specified position. When next time NovaLCT is started, the main window will be displayed in the target position.

11.4 Change UI Language

Applications

Change the UI language for NovaLCT.

Applicable Products

N/A

Prerequisites

None

Related Information

NovaLCT supports Deutsch, English, Spanish, French, Japanese, Korean, Portuguese, Russian, Thai language, Traditional Chinese and Simplified Chinese.

Operating Procedure

On the menu bar, choose **Language** and select the target language from the sub-menu.

11.5 Obtain Help Information

Applications

Check the user manuals, update log and software information of the current version of NovaLCT, and contact online customer service.

Applicable Products

N/A

Prerequisites

None

Related Information

None

Operating Procedure

Choose **Help** from the menu bar and do the corresponding operations below as needed.

✦ **Check User Manuals**

Choose **User Documents** and select the desired user manual.

✦ **View Update Log**

Choose **Update Log** to view the update log in the displayed dialog box.

✦ **View Software Information**

Choose **About** to view the software version and copyright information in the displayed dialog box. If needed, click the link to visit the official website of NovaStar.

✦ **Contact online customer service**

Choose **Online Support**. On the displayed page, chat with the customer service online.

11.6 Update Software

Applications

When the Internet is available, download the NovaLCT update package from the cloud and install it.

Applicable Products

N/A

Prerequisites

The control computer is connected to the Internet.

Related Information

None

Operating Procedure

Step 1 From the menu bar, choose **Help > Online Update**.

Notes

If NovaLCT is not up to date, after NovaLCT is opened, an "Online Update" dialog will be displayed.

If there is an available new version, an  icon is displayed in front of the **Online Update** menu name.

Figure 11-4 Online update



Step 2 Click **OK**.

Step 3 Click **Get Update**.

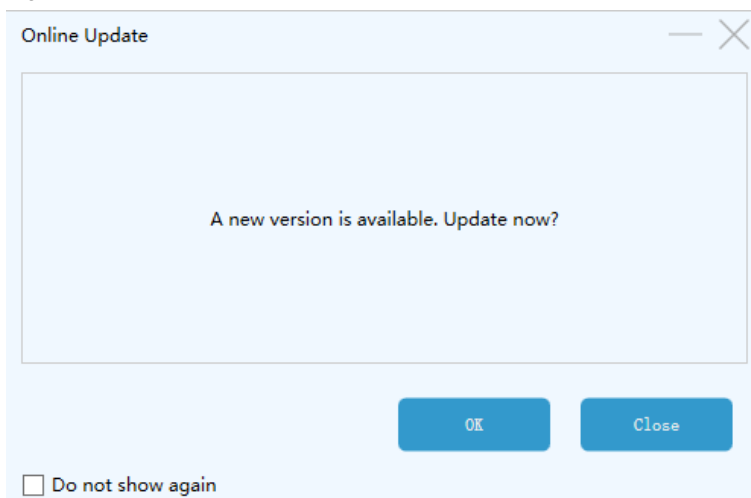
Step 4 After the update package is downloaded, click **Install Update** and wait for it to complete.

Figure 11-5 Installing update

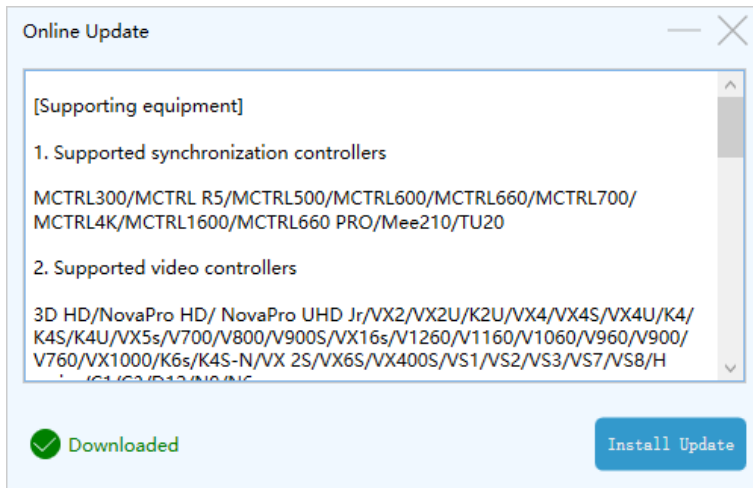

12 Troubleshooting

12.1 Installation Problems

12.1.1 Failed to install NovaLCT of earlier versions

Problem

The installation of NovaLCT fails when the version to be installed is earlier than the current version.

Possible Causes

None.

Solution

Uninstall the current version, and then install the earlier one.

12.1.2 .NET Framework is missing

Problem

When installing NovaLCT, you run into a system prompt like "To run this application, you must first install one of the following versions of the .NET Framework." (This typically appears on computers that have not previously installed NovaLCT.)

Possible Causes

The required .NET Framework version is missing on the computer where NovaLCT is installed.

Solution

Visit NovStar's official website (www.novastar.tech) and download the required .NET Framework.

Download path: Downloads > Software > Framework

Figure 12-1 Download .NET Framework

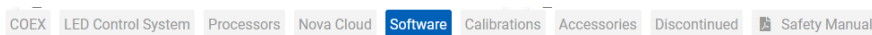

NovaLCT

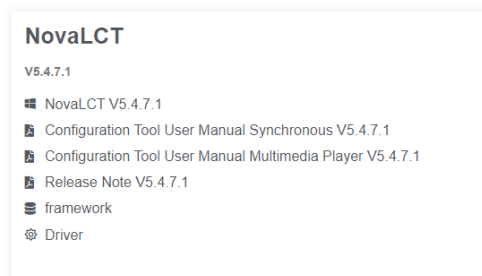
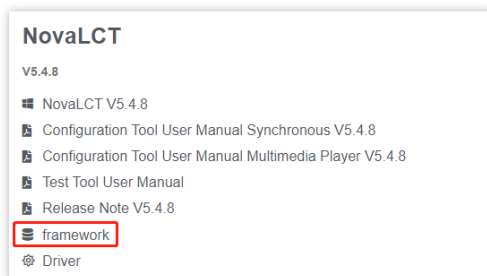

12.1.3 "DeleteFile failed" error

Problem

When installing NovaLCT, you run into a system prompt like "An error occurred while trying to replace the existing file. DeleteFile failed with code 5. Access denied."

Possible Causes

The monitoring daemon is still running after shutting down NovaLCT, causing some files to be unable to be deleted.

Solution

Open the task manager, right-click on "MonitorDaemon", select "End task" from the pop-up menu, then click "Retry" to proceed with the installation of NovaLCT.

Figure 12-2 Task manager

Name	Status	17% CPU	95% Memory	7% Disk	0% Network
Apps (5)					
> MonitorDaemon		0.2%	8.9 MB	0 MB/s	0 Mbps
> NovaLCT (32 bit) (3)		0%	127.8 MB	0.1 MB/s	0.1 Mbps

12.1.4 Prompts to run DPinst.exe

Problem

At the end of the installation process for NovaLCT, when starting the installation of the driver, you run into a system prompt like "You need to run the 64-bit version of DPinst.exe on this computer. Please contact the software developer who provided you with this software package." (This typically appears on computers that have not previously installed NovaLCT.)

Possible Causes

The required driver is missing on the computer where NovaLCT is installed.

Solution

Proceed with the installation disregarding the issue at hand. Once completed, test if NovaLCT is able to connect to the device via the USB cable.

- If you are able to connect to the device with no issue, there is no need for any further action as NovaLCT can be used as intended.
- If you are unable to connect to the device, visit NovStar's official website (www.novastar.tech) and download the required driver. Please contact NovaStar if the problem persists after installing the driver.

Download path: Downloads > Software > Driver

Figure 12-3 Download driver

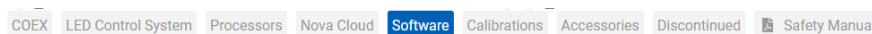

NovaLCT

NovaLCT

V5.4.8

- NovaLCT V5.4.8
- Configuration Tool User Manual Synchronous V5.4.8
- Configuration Tool User Manual Multimedia Player V5.4.8
- Test Tool User Manual
- Release Note V5.4.8
- framework
- Driver**

NovaLCT

V5.4.7.1

- NovaLCT V5.4.7.1
- Configuration Tool User Manual Synchronous V5.4.7.1
- Configuration Tool User Manual Multimedia Player V5.4.7.1
- Release Note V5.4.7.1
- framework
- Driver

12.2 Other Problems

12.2.1 "No Screen" displayed in NovaLCT

Problem

"No Screen" is displayed in NovaLCT as shown in [Figure 12-4](#).

Figure 12-4 No screen

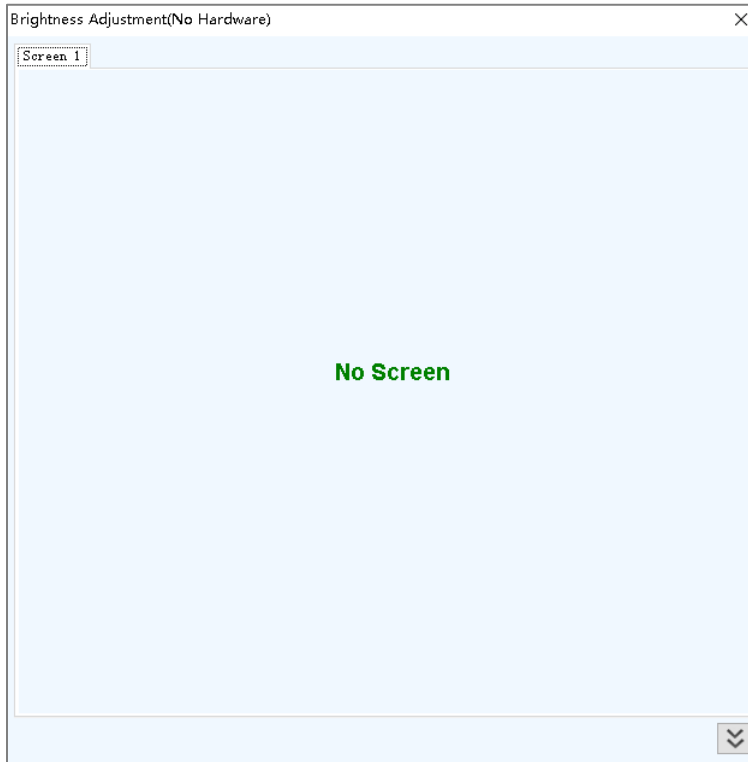

Possible Causes

Failed to read screen configuration or no screen has been configured.

Solution

- If the LED screen has been configured already, click  and select the Screen Connection tab, and then click Read from HW to read the configurations from the LED screen.
- If the screen has not been configured yet, configure it first.

12.2.2 Permission error

Problem

After NovaLCT is installed on the system disk of the computer that runs Windows 8 or later version, some functions in NovaLCT cannot work normally.

Possible Causes

File permission denied.

Solution

Here, we use Windows 10 as an example to illustrate how to solve this problem.

Step 1 Right click the desktop shortcut of NovaLCT and select **Open file location**.

- Step 2 Go back to the upper level of current file directory, that is, “\Nova Star\NovaLCT”.
- Step 3 Right click the **Bin** folder and select **Properties**.
- Step 4 Select the **Security** tab.

Figure 12-5 Security

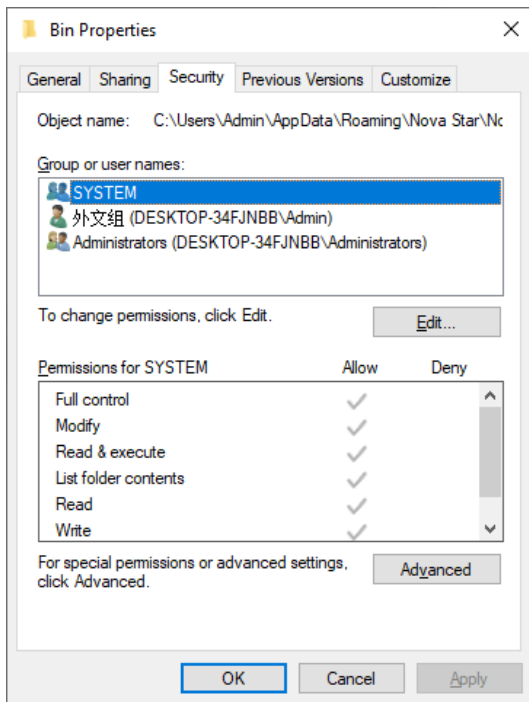

- Step 5 Check whether there is current user or **Everyone** in the **Group or user names** area.
 - Yes: Go to Step 11.
 - No: Go to Step 6.

Step 6 Click **Edit** to open the dialog box shown in [Figure 12-6](#).

Figure 12-6 Changing permissions

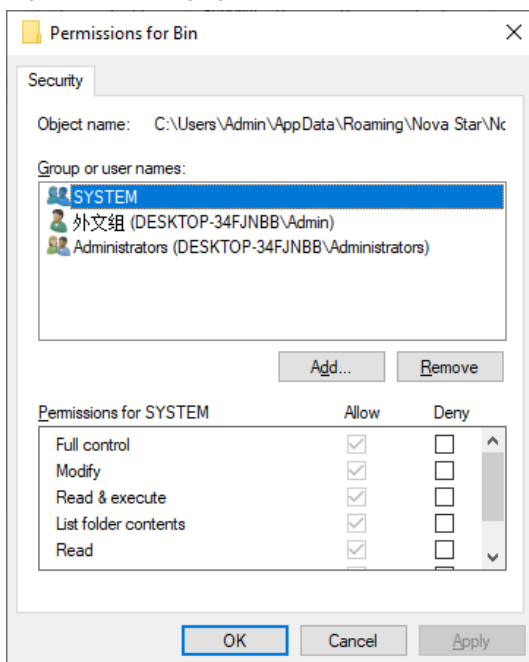

Step 7 Click **Add** to open the dialog box shown in [Figure 12-7](#).

Figure 12-7 Selecting users or groups

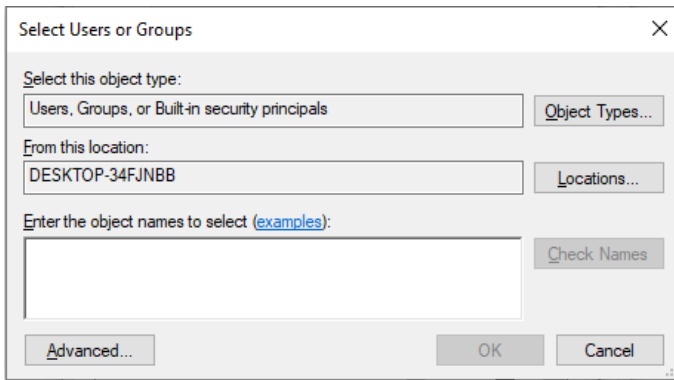

Step 8 Click **Advanced** to open the dialog box shown in Figure 12-8, and click **Find Now**.

Figure 12-8 Advanced settings

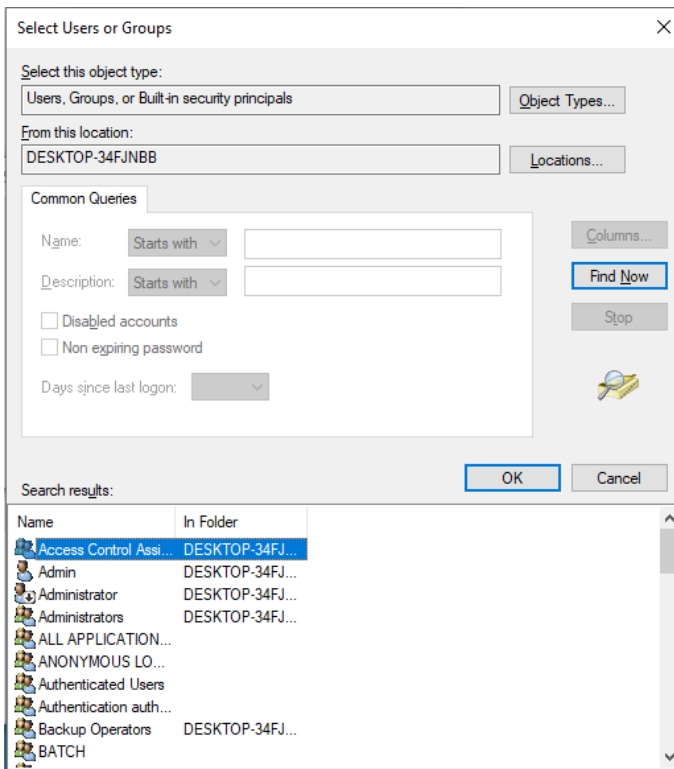

Step 9 Select current user or **Everyone** in the search result, and click **OK**.

Step 10 Click **OK**.

Step 11 Select all for the **Allow** column and click **OK**.

Figure 12-9 Setting permissions

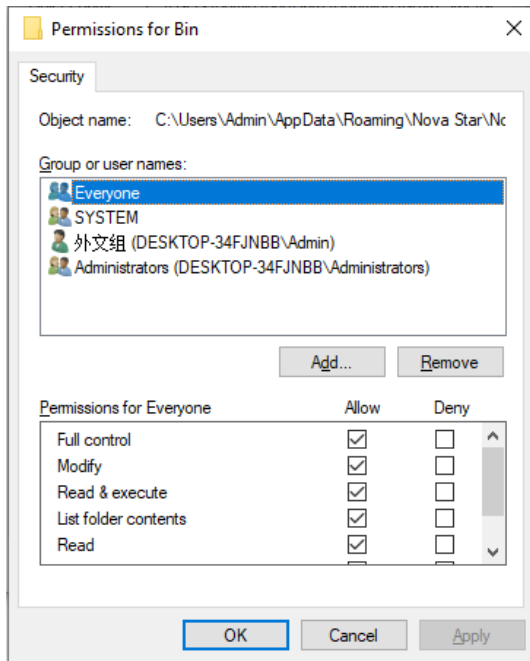

Step 12 Click **OK** and close the properties dialog box.

12.2.3 Failed to connect colorimeter

Problem

The colorimeter connection fails when the colorimeter is used to automatically measure the original color space of the screen.

Possible Causes

- The colorimeter connection is abnormal.
- The model of the colorimeter selected is incorrect.

Solution

Step 1 Check whether the hardware connection of the colorimeter is normal.

When the colorimeter model is CS-100A, follow the subsequent descriptions to make sure the colorimeter auto mode is turned on.

Turning on auto mode: Set switch to ON while pressing the F button. When you see a C letter on the LCD, the auto mode is turned on, which is shown in [Figure 12-10](#).

Figure 12-10 Setting CS-100A colorimeter



- Normal: Go to .

- Abnormal: Reconnect the colorimeter and make sure the colorimeter can work normally.
- Check whether the colorimeter model selected in NovaLCT is correct.
- Correct: Go to Step 2.
- Incorrect: Select the correct model.

Step 2 In NovaLCT, click **Connect** to reconnect the colorimeter.

12.2.4 No available server for VNNOX Care

Problem

No available server from the dropdown list for VNNOX Care services.

Figure 12-11 VNNOX Care services

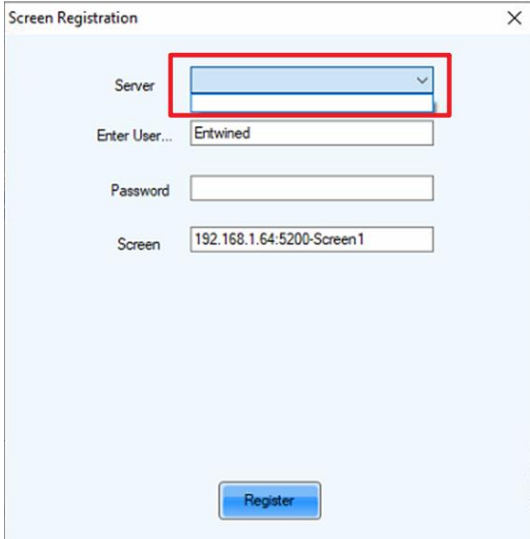

The screenshot shows a 'Screen Registration' dialog box. The 'Server' dropdown menu is highlighted with a red rectangle. The 'Enter User...' field contains 'Entwined'. The 'Screen' field contains '192.168.1.64:5200-Screen1'. A 'Register' button is located at the bottom of the dialog.

Possible Causes

The network or antivirus software may be the cause of the issue.

Solution

You can try the following methods to resolve this issue:

- Disable your computer's firewall or your company's network firewall and try again. Or try from a different computer if the problem persists.
- Uninstall the antivirus software (release the quarantined files) and reinstall NovaLCT.

13 FAQs

13.1 How do I set the required parameters in no sending card mode?

Question

The receiving card supports no sending card mode. When the hardware connection with no sending card is completed, how to set the required parameters?

Figure 13-1 No sending card mode

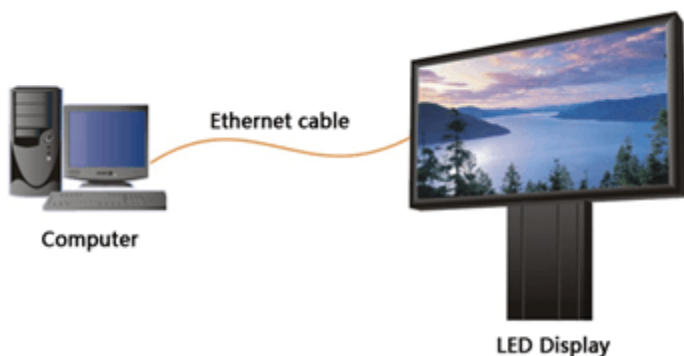

Answer

- Step 1 Make sure the network card allows a data transmission rate of 1000 Mbps.
- Step 2 On the taskbar, right click  and choose **Detect Config**.
- Step 3 Select Enable virtual controller and click **OK**.

Figure 13-2 Enabling virtual controller



- Step 4 On the taskbar, right click  and choose **Select Network Card**.
- Step 5 Choose a network card and click **OK**.

Figure 13-3 Choosing network card

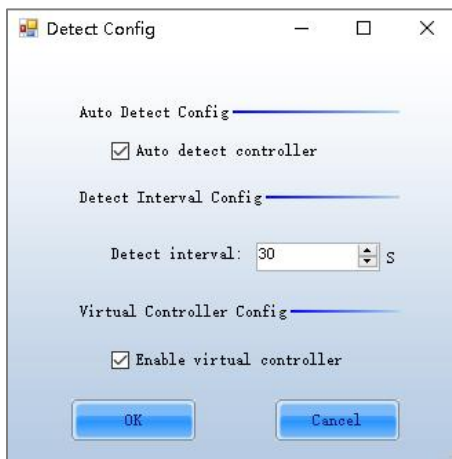

13.2 How do I set the proxy when NovaLCT needs to access WAN network?

Question

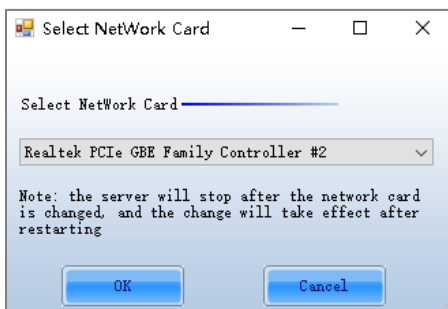
When NovaLCT in LAN network needs to access WAN network, how to set the proxy?

Answer

Step 1 On the taskbar, right click  and choose **System Setting**.

Figure 13-4 Setting proxy

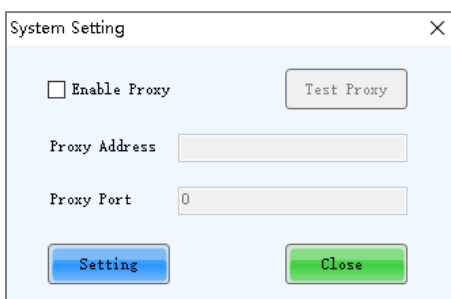

Step 2 Select **Enable Proxy**.

Step 3 Enter the proxy address and port.

Step 4 Click **Test Proxy**.

Step 5 After the test succeeds, click **Setting**.

Copyright © 2024 Xi'an NovaStar Tech Co., Ltd. All Rights Reserved.

No part of this document may be copied, reproduced, extracted or transmitted in any form or by any means without the prior written consent of Xi'an NovaStar Tech Co., Ltd.

Trademark

 is a trademark of Xi'an NovaStar Tech Co., Ltd.

Statement

Thank you for choosing NovaStar's product. This document is intended to help you understand and use the product. For accuracy and reliability, NovaStar may make improvements and/or changes to this document at any time and without notice. If you experience any problems in use or have any suggestions, please contact us via the contact information given in this document. We will do our best to solve any issues, as well as evaluate and implement any suggestions.

[Official website](http://www.novastar.tech)
www.novastar.tech

[Technical support](mailto:support@novastar.tech)
support@novastar.tech